

CHAMPION SIDECARS
DAYTONA 2+2, LEGEND AND ESCORT
OWNERS MANUAL
(HARLEY DAVIDSON SIDECAR GENERAL INSTRUCTION)



Champion Sidecars Inc.
11841 Monarch Street
Garden Grove, CA 92841

(800)875-0949 (sales)

(714)847-0949 (customer service)

(714)375-5668 (parts)

(714)847-1539 (fax)

http://www.champion_sidecars.com (web site)

carrojo@surfside.net (e-mail)

TABLE OF CONTENTS

SPECIFICATIONS -----	3
Information on tire size, wheel bearings, brake pads tire air pressure, T.I.L.T. actuator and information regarding the removal and re-installation of your sidecar.	
GENERAL -----	4
Drawing of frame and suspension parts inc frame and suspension parts list	
ELECTRICAL -----	5
Wiring harness pin location and color call out for wiring harness installation to motorcycle.	
Wiring of fuse link, ground, clock and accessories. brake lights, running lights, right turn signal, and back up light.	6
wiring of canopy switch (Daytona Sidecar) T.I.L.T. electrical installation. Wiring instructions Legend Sidecar	
INSTALLATION OF REAR SUB FRAME -----	7
CONTINUED INSTALLATION OF SUB FRAME -----	8
INSTALLATION OF UPPER FRONT MOUNT -----	9
INSTALLATION OF LOWER FRONT MOUNT -----	9
BRAKES -----	10
PREPARATION AND MOUNTING OF SIDECAR TO MOTORCYCLE -----	10
This section covers all aspects of installing the sidecar to the motorcycle including helpful hints for pre installation.	
Mounting of sidecar continued. This section includes instructions on wheel lead, toe in, and torque specs.	11
Mounting of sidecar continued to include diagram showing the correct frame height and location of measurement points for the Daytona, Legend and Escort sidecar installation.	12
Mounting of sidecar continued. Diagrams showing hardware used in the installation of the Daytona, Legend and Escort sidecar. This section also covers some information regarding the chrome struts.	13
STEERING DAMPER -----	14
Photo showing installation of steering damper	
DRIVING A SIDECAR -----	15
Helpful hints and safety precautions for the first time sidecar rider and sidecar passenger. Also information regarding what to expect when you take your sidecar for its first ride.	

Escort (E) Daytona (D) Legend (L)**SPECIFICATIONS**

TIRE (E)(D)	-----	145SR13 DUNLOP
Tire (L)	-----	130 x 90 x 16"
WHEEL (E)(D)	-----	#22-3511 4 x 100 modified to 4 x 4
Wheel wire (L)	-----	Wire 16"x3"84 up FXST
Wheel alloy (L)	-----	Alloy 10 spoke HD #43345-87
WHEEL BEARINGS (E)(D)	-----	#L44643 bearings L44610 race
WHEEL BEARING SEAL(E)(D)	-----	#AD7128EO
BRAKE PADS(E)(D)	-----	#220018 Brembo
SHOCK Progressive	-----	Escort#6602-007 Daytona#6602-011
T.I.L.T. ACTUATOR (All)	-----	20A at 1500 lbs.

CARE AND MAINTENANCE

PAINT Champion uses only PPG paint products for maximum quality and finish. Your sidecar is painted using only base coat/clear coat urethane finishes. This finish is hand polished at the factory and requires very little maintenance except normal wash and wax. It is advisable not to wax your sidecar for roughly three to four weeks after receiving it in order for the paint to cure thoroughly.

WHEEL BEARING MAINTENANCE The wheel bearings used on your sidecar are automotive grade tapered wheel bearings. It is advisable to check the wheel bearing adjustment periodically, and to clean and re-pack the bearings roughly every 3000 miles. These bearings and seals are available at most automotive part stores.

TIRE AND TIRE AIR PRESSURE The tire used on your Daytona or Escort sidecar is manufactured by the Dunlop Tire Co. and is available at most tire centers. This tire is manufactured to automotive stress and wear factors that are much higher than those you will ever experience with your sidecar. There is a good chance that through normal use of your sidecar you will never wear out the tire tread, but you must inspect the tire periodically for air pressure, dry rot and sidewall damage. The manufacturer recommended air pressure for this tire is 28 lbs. psi, but because of the light duty application this tire is being used for, you may want to experiment with the tire pressure to enhance the suspension comfort.

Tire pressure for the legend should be maintained at 40 PSI.

SHOCK SUSPENSION The shock suspension used on the Daytona, Legend and the Escort sidecar are manufactured by Progressive Suspension. Progressive Suspension has a reputation for manufacturing high quality aftermarket motorcycle shocks and springs. Although the sidecar is shipped to you from the factory with the shock spring set at it's softest setting, there are a total of five performance adjustments you can set your shock spring at.

SIDECAR REMOVAL AND REINSTALLATION To remove the sidecar from the motorcycle first remove the two ½" bolts connecting the struts to their upper eye mounting positions. Be sure to have someone support the motorcycle as you remove the last of the ½" bolts . Now with the side stand in it's down position lean the motorcycle to the left so it rests on the side stand. Now with the sidecar frame supported with a jack or dolly remove the two lower 5/8" bolts connecting the lower mounting positions.

Disconnect the wiring harness plug, brake quick coupler, and steering damper if you are using one. Now slide the sidecar away from the motorcycle. (**IMPORTANT NOTE**)(**UNLESS IT IS YOUR INTENT TO RE-ALIGN THE SIDECAR DO NOT LOOSEN ANY OF THE JAM NUTS OR PINCH BOLTS DURING REMOVAL OF**

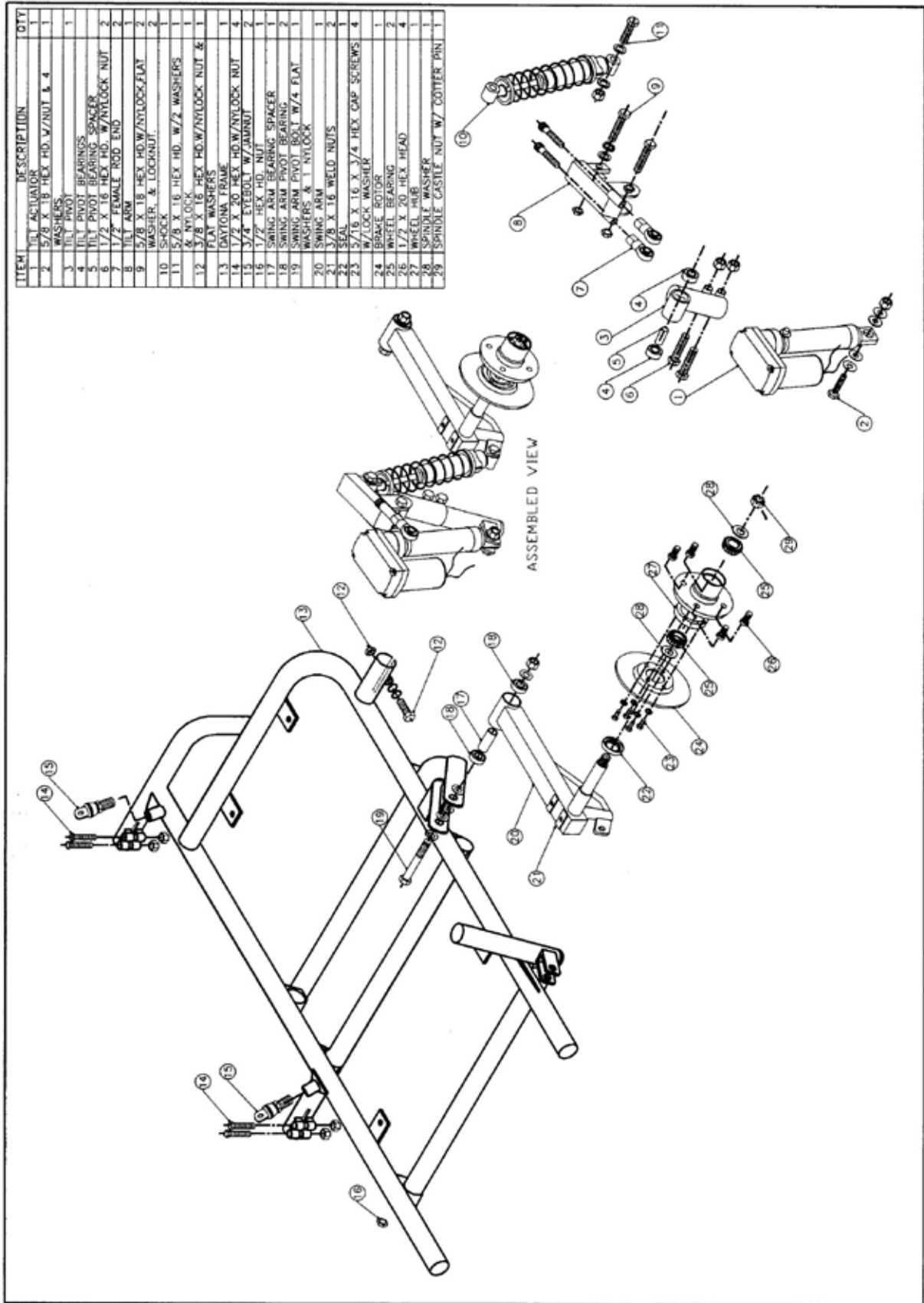

ELECTRICAL

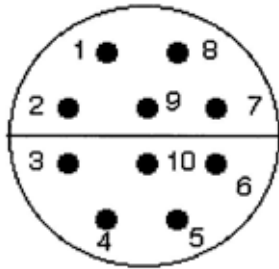

SIDECAR POWER CONNECTOR (sidecar side)
Motorcycle Wiring Diagram Code (Escort, Daytona)

Pin #	Description	Color	Gauge
1	Clock	Green	22
2	Accessory	Red	18
3	Ground	Black	18
4	Brake Light	Red	22
5	Running Light	White	22
6	Right Turn Signal	Yellow	22
7	Backup Utility	Blue	22
8	Canopy Switch on Bike	Orange	22
9	TILT (all models)	Yellow	14
10	TILT (all models)	Pink	14

TILT Switch Wiring Colors (all models)

Positive Battery (+)	Red	14
Negative Battery (-)	Black	14
Harness Yellow	14	Yellow 14
Harness Pink	14	Purple 14

WIRING LEGEND SIDECAR - red (stop), green (running), black (- battery)

Wiring Description (Most applications require the removal of the seat.)

* **Fuse link** When connecting wires directly to the positive terminal of the battery always use a fused connection to prevent fire or damage to motorcycle and sidecar if a short occurs.

* **Ground** The ground wire should be connected directly to the battery ground or negative terminal or to another suitable frame ground. The ground connection on the sidecar is not connected to the sidecar frame, however the sidecar frame is connected to the motorcycle frame.

* **Clock** The clock signal is used for supplying constant power to the backup circuit of a stereo. This should be connected directly to the positive terminal of the battery or any other wire that is always live . IF you are not installing a stereo in the sidecar this wire can be left disconnected.

* **Accessories** This should be attached to the switched accessory terminal of your bike. If you are already using this circuit, it would be advisable to

use the accessory terminal to control a relay that feeds this. This will prevent overloading the accessory circuit on your bike.

*** Brake Lights, Running Lights, Right Turn Signal, Backup light**

These wires need to attach to the corresponding signal from the motorcycle. There are several ways to do this. The first method is to **remove the seat** and locate the corresponding wires with the use of a test light. The second method although more expensive is to install a Station 9 from Kriss Industries, where most of the wires to the sidecar can be isolated and fused. If you do not have a reverse gear on your motorcycle the sidecar backup light makes a very useful utility light when wired to a positive battery connection and to a switch.

We suggest that you remove the right turn signal bulbs from your motorcycle and cover the appropriate terminals with a small piece of electrical tape; then replace the bulbs. This will prevent any confusion by following motorists that could result from having two signals flashing, especially at night when the extra signal appears to be in the center of the vehicle. If you remove the sidecar, remember to put the bulbs back to their original condition.

*** Canopy Switch on Bike** (Daytona Sidecar) This goes to a momentary switch installed anywhere on the bike to open the canopy latch. It is recommended that the power to this switch comes from switched power on the bike , thus only allowing the canopy to be opened when the bike is switched on.

*** TILT** There are a total of 6 wires involved in the TILT system. The red and black wires of the second harness need to go to the positive and negative terminal of the battery respectively.. This is because of the high current draw. The switch is momentary only and therefore cannot cause unnecessary drain on the battery. You must run the power for this through a 20 amp fuse. The yellow and purple wires from the switch are connected directly to the yellow and pink wires from the harness using the butt connectors provided.

Mount the switch in a convenient location on the left side of your fairing. The switch should be mounted so that moving it to the left or away from the sidecar causes the sidecar to lift and the motorcycle to lean to the left. Moving the switch to the right or toward the sidecar should cause the sidecar to lower and cause motorcycle to lean to the right.

WIRING LEGEND SIDECAR

The wiring of the legend sidecar can be accomplished by first removing the seat of your motorcycle and with the use of a test light locate the brake light wire connection , the tail light wire connection and the battery positive terminal. Now using the hardware supplied connect the red wire from the sidecar harness to the motorcycle brake light connection, the black wire to the negative battery post and the green wire to the motorcycle tail light connection. If you have ordered other accessories

such as driving light, interior light etc. it will be necessary to locate you motorcycle accessory lead or positive battery terminal for this connection. **(NOTE)** Remember to use a fused connection if you are connecting to the battery. And if you are connecting to your motorcycle accessory lead it may be necessary to use a larger amperage fuse.

1996 - 1997 Harley Davidson FLH Hardware Instructions

Figure 1

1. Remove the seat.
2. Remove the right side passenger and driver foot rest.
(Allen hex head bolt)
3. Remove the front lower crash bar bolt.
4. Remove the saddlebag crash bar upper mount.
5. Take the rear mount Fig 1 and starting with the passenger foot rest put the bolts in place from the center out. Leave the bolts loose until the lower rear and upper rear mounts are connected together Fig 3 # 2 and all the bolts are in place.
6. Now install the lower rear mount to the frame rails as shown in Fig #2 . Now tighten all bolts to the upper rear mount and the lower rear mount.

If you are installing the sidecar to a FLHTCU with front lower leg guards it will be necessary to remove the right side. (This part will not be reinstalled)



1. Number 1 of (figure 2) shows the location of crash bar mount located under the seat (position the mount under the factory crash guard).

Figure 2

2. Number 2 of (Figure 1) shows the location of the mount to the foot rest bolt.

3. # 1 and # 2 of (figure 2) shows the location of the lower rear sub frame to the motorcycle frame. Take notice of the clamp location and the bolts supplied by Champion.

4. Number 2 of (figure 3) shows the bolt supplied by Champion that is used to connect the upper rear and lower rear sub-frame together.



Figure 3

Figure 4
(1996-1997)
Lower Front Mount (figure 4)

Remove the two socket head cap screws holding the right floorboard. Remove the bolt holding the bottom of the crash guard. Install the mount between the crash guard and the frame and replace the crash guard bolt. Align the mount slots with those for the floorboard and replace the floorboard. Now tighten all bolts .



98 - 2000 FLH REAR MOUNT



(FIG 2)

(FIG 3)

(FIG 4)



1. Number 3 of (figure 2) shows location of crash bar mount located under the seat (position under factory crash guard).

2. Number 2 of (Figure 2) shows location of mount to foot rest bolt.

3. Number 1 of (figure 2) shows the location of the 7/16" bolt supplied by Champion installed to open threaded in bike frame.

4. Number 1 of (figure 3) shows 1/2" bolt supplied by Champion used to connect part A & B of the rear sub-frame.

5 # 1 and # 2 of (Figure 4) shows the two clamps and bolts connecting the lower rear mount to the bike frame.



02/03 REAR MOUNT

Upper Front Mount (1984 through 2003)

Eye Clamp Assembly

Install the strap clamp (figure 5) as high as possible on the right side vertical frame tube. Do not tighten the eye bolt at this time. Note: Be sure to install the two 1/4 bolts from the rear with the nuts facing forward to allow sufficient clearance between the bolt heads and the engine.

(FIG 6)

Remember the engine moves when it is running and if the clamp bolts are too close it could damage the head finish.

7)

(FIG 5)



(FIG

Lower Front Mount (figure 7 & 8)

Remove the two socket head cap screws holding the right floorboard. Remove the bolt holding the bottom of the crash guard. Install the mount between the crash guard and the frame and replace the crash guard bolt. Align the mount slots with those for the floorboard and replace the floorboard. Now tighten all bolts.

(FIG 8)



(Fig 9)

BRAKES (IF EQUIPPED) Locate the rear brake master cylinder usually located near the rear brake pedal. The brake connection is accomplished by removing the existing banjo bolt connecting the rear brake line to the rear master cylinder and replacing it with a longer double banjo bolt supplied by Champion. The double banjo bolt will go through both the new brake quick coupler banjo end and the existing brake cable banjo end shown (Figure 9). (**be sure to use new crush washers between all banjo fittings and connecting surfaces**). The brake cable to the sidecar is aircraft quality steel braided hose with a quick disconnect coupler. This

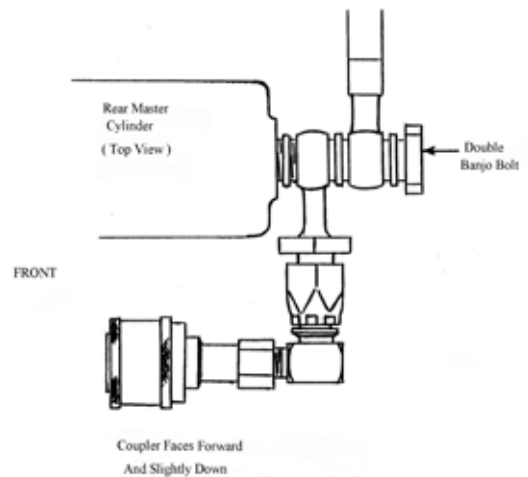

coupler is sealed in both directions to prevent any brake fluid from leaking out. Because your Harley Davidson uses DOT 5 brake fluid from the factory and because DOT 5 brake fluid is not compatible with the brakes used on your sidecar it will be necessary to drain and refill the rear brake system with DOT 4 brake fluid and re-bleed the motorcycle rear brake system. The sidecar is shipped without any brake fluid so it will be necessary to replace the fluid with DOT 4 brake fluid and bleed the brake system before riding the sidecar combination. Also at any time the rear brake pedal feels spongy or softer than normal, the sidecar brake line should be bled and checked.

(NOTE) It is recommended to bleed the brakes every 3rd. or 4th time the sidecar is removed.

PREPARATION AND MOUNTING PROCEDURES

ATTACHING THE SIDECAR

Mounting the sidecar should be done on a level even floor surface. The sidecar frame should be supported at the front and rear cross member on 4x4 blocks or stands adjusted to a length of six and a half inches for the rear and seven and a half inches in the front for the Daytona and Escort (Figure L). If the sidecar you are installing is our Legend sidecar the front measurement should be nine inches and the rear measurement is seven and three quarter inches Figure L-1. If you have T.I.L.T. installed on the sidecar, retract the wheel to ensure the wheel does not support the weight of the sidecar. Slide the front and rear mounting hardware into the sidecar frame. To ease adjustments, excess powder coat may have to be trimmed off the leading edge of the tubes before being inserted into the frame tubes. For the **Escort** and **Daytona** installation the front uses the 45 degree boss and 45 degree clamp while the rear uses the 70 degree boss and 70 degree clamp. For the **Legend sidecar** front hardware installation the offset clamp

will slide into the sidecar frame first and then install the 45 degree clamp and 45 degree boss to the offset clamp. The rear mounting hardware will use a 70 degree clamp and a 70 degree boss.

THE SIDECAR) To reinstall the sidecar reverse the process.

The motorcycle ride height should be adjusted to simulate your current riding height. This can usually be accomplished by removing all the air from your rear shocks to a close approximation of bike height with a rider on it.

Wheel the motorcycle alongside the sidecar in preparation for an average 60 inch MC wheel to SC wheel measurement. Use two jack stands to balance the motorcycle. One should be placed under each rear bag guard and adjusted to just balance the motorcycle not support it as full weight should be on the suspension. A false setting of the frame or MC suspension will require you to readjust the alignment settings just when you think everything is completed.

The wheel lead should be set at approximately 9 ½" as per the diagram (Figure M location C). The toe in measurement (Figure M) should be approximately 1" less at location B then location A . This measurement can easily be accomplished using a long straight edge supported off the ground about 4" and resting against the sidecar tire. The straight edge should be 5' to 6' long. If you do not have a long straight edge, a 6' fluorescent bulb will work fine.

Engage the lower rear mount insert then snug up the 5/8" through bolt. Do the same for the front lower mount. All the half inch fasteners should be final torque to 80 ft lbs. at this time. After you have torqued the half inch pinch bolts to 85 ft. lbs., you should now install the rear strut and front strut from the sidecar frame eye to the upper rear mount eye. It may be necessary to rotate the eyes on the frame and the upper mounts slightly for strut installation (only turn the top front frame eye clockwise for this adjustment). **After the pinch bolts have been torqued and struts installed, you should remove the supports holding the sidecar at its correct height. This will assure that the sidecar remains level after installation.** The motorcycle should be set up so that it leans away from the sidecar. (ie, the upper part of the rear wheel) should be about 1/4" further away from the SC than the bottom of the MC wheel. The lean out or lean in of the motorcycle is accomplished by adjusting the struts only. If you have the optional **TILT (trimming device)** it is a good idea to first lower the sidecar to its full down position and then raise it one inch to do the final strut adjustment. This will allow three inches of up adjustment and one inch of down adjustment. **NOTE** If the sidecar does not drift left or right at a cruising speed of approximately 50 mph and with the passenger weight that would normally be in the sidecar , you have adjusted the lean of the motorcycle correctly. If the motorcycle drift's to the right and the toe in has been checked and found to be correct adjust the struts and lean the motorcycle to left in small increments and vice-versa if it pulls to the left.

RE-Check Ensure that all fasteners have been torqued to the correct values. Do not forget the jam nuts in the struts or frame mounts! Bleed the brake system and check SC brake operation with the SC wheel lifted off

the ground. ---Enjoy!---

Figure L, is showing the correct frame height and location of measurement points for the **Daytona** and the **Escort** sidecar installation.

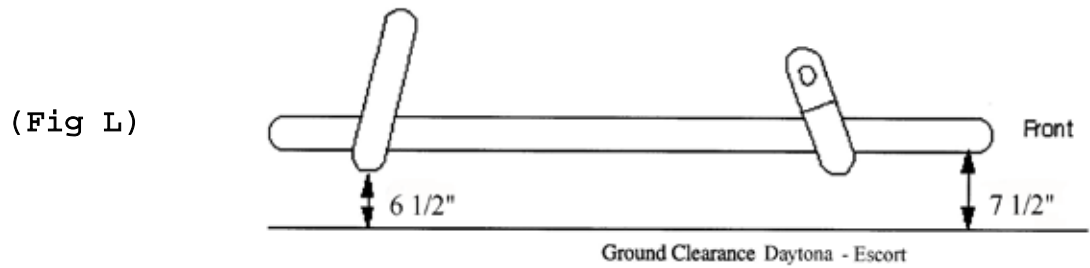

Figure L-1, is showing the correct frame height and location for measurement points for the **Legend** sidecar installation.

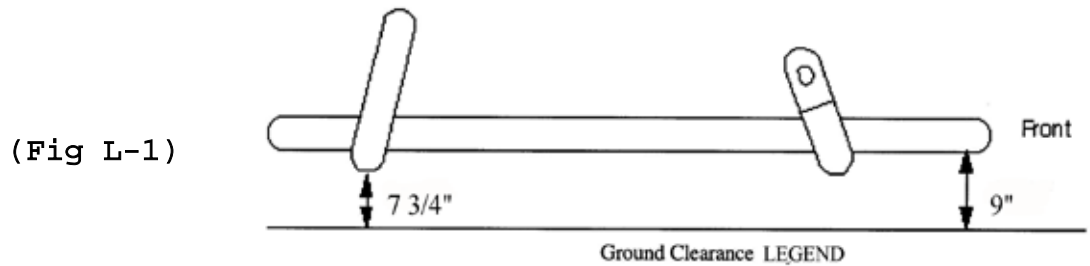

Figure M is showing the correct measurement points for toe in and wheel lead for the Daytona Legend and Escort sidecar.

Harley Davidson toe in and wheel lead specifications.

Toe in measurement at Figure (B) should be approximately 1" less than at Figure (A).

Wheel lead Figure (C) should be approximately 9 1/2"

Also the measurement at Figure A should be approximately 54".

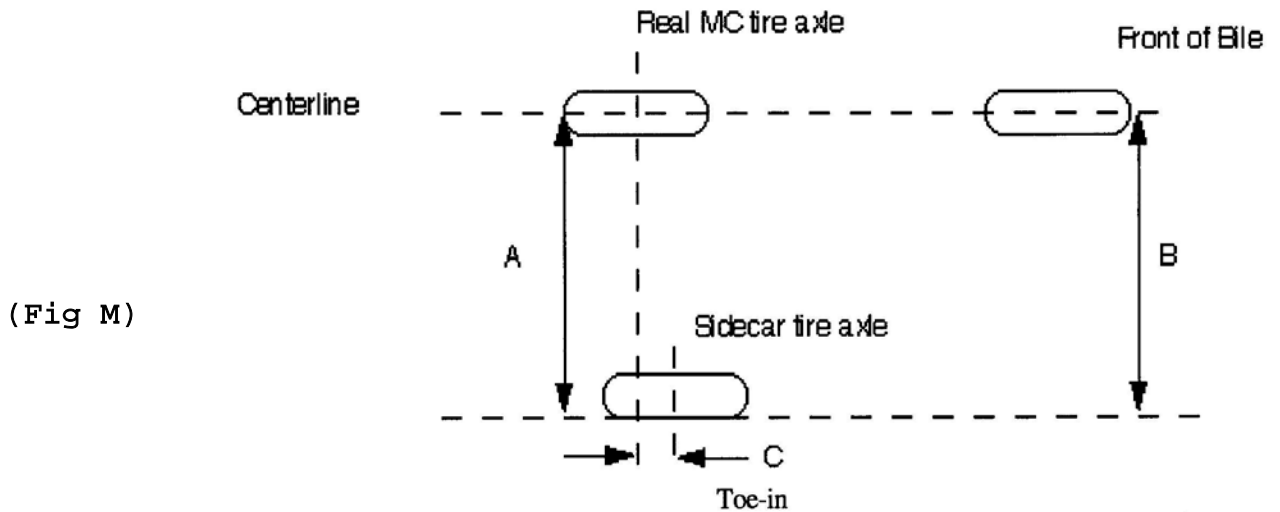

Chrome Struts

Push the outer sleeve downward with a slight twisting to free it from the retaining

O Ring. This will allow access to the jam nut. (keep O ring lubricated)

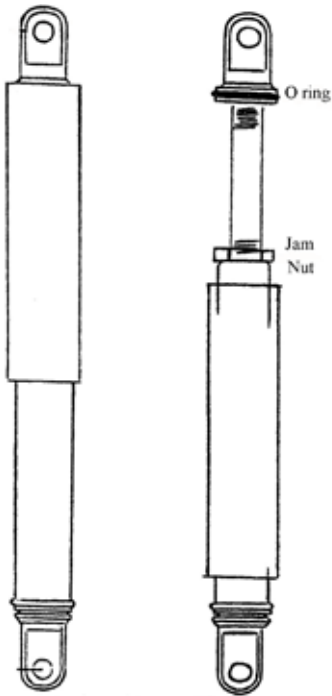

Rear Hardware

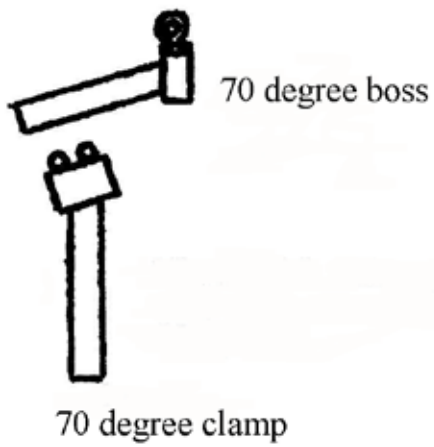

Front Hardware

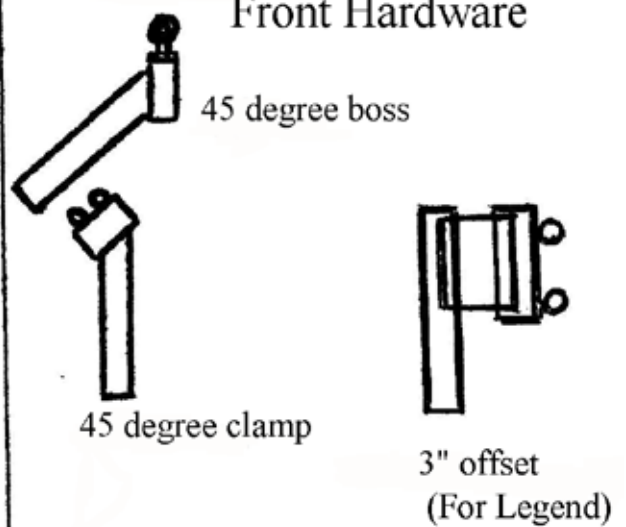

Steering damper installation

Install the clamp around the fork leg just above the fender mounting bolts but high enough to clamp securely. (Caution) Be sure the clamp is low enough to clear the outer fork cover under full compression of the suspension. Also make sure steering is full lock to lock. (size)?

(Picture damper mount to sidecar frame and fork)



DRIVING A SIDECAR

NEW OWNER DRIVING AND SAFETY PRECAUTIONS

It is important to know that driving a sidecar will be nothing like riding a solo motorcycle. So take my advice and forget most of the twenty years of experience you have spent riding motorcycles and be prepared to spend some time to change habits and learn some new tricks.

First of all **forget leaning the motorcycle** into a turn (it will not happen) so remember if you do not turn the handlebars into a turn the motorcycle will go straight. This may sound funny but many times old habits are very strong and hard to break.

Remember also that there is a sidecar attached to the right hand side of you motorcycle and you must make a mental note to stay to the left side of your lane. It is no longer necessary and is **unsafe** to lower your feet from the foot pegs when the vehicle is moving, except when you want to push the rig in reverse.

(FLYING THE CHAIR)

It is very possible that on a fast or tight right hand turn the sidecar wheel will lift off the ground. For the first time rider it is a good idea to avoid this maneuver until you become more familiar with your sidecar. The lifting of the sidecar wheel can be avoided in a number of ways. The first and most common method is simply slow down on right hand turns until you become familiar with your sidecar. The second method is to make sure that there is always a passenger or additional weight in the sidecar and to avoid having a passenger on the back of the bike when the sidecar is empty. (but still watch your speed on right turns). After you become more familiar with your sidecar you may want to take the rig into an empty parking lot with no obstructions for the following maneuver. Put the sidecar rig into a right hand turn and slowly increase the speed and the tightness of the turn until the sidecar wheel comes off the ground. This maneuver will allow you to safely experience what it feels like to have the wheel off the ground and will avoid the unknown if it happens by accident while driving the rig. **Because it only put's unnecessary stress on the sidecar mounting hardware the raising of the sidecar should only be for learning purposes.**

It is normal to feel the rig want to pull slightly to the right when accelerating because of the pull of the sidecar and a slight pull to the left when backing off the throttle. This is a normal reaction of attaching a sidecar to a motorcycle and after you have some riding experience with your sidecar you will hardly notice it. Some motorcycle sidecar applications will experience what we call low speed (wheel-wobble)and it usually occurs between first and second gear at about twenty or thirty MPH. If you are experiencing intolerant wheel-wobble and you are sure the toe in measurement and wheel lead settings are correct you may want to install a steering damper (available from Champion) to the front fork of your motorcycle.

It is also normal if you do not have a brake on your sidecar to feel a

slight pull to the left when stopping you rig. This is because the sidecar wants to come around the motorcycle when stopping. If you are stopping and you do not have a brake you may want to counter steer into the sidecar in order for the rig to stop straight. (A brake at the sidecar wheel is a safety benefit and should be installed especially when driving on wet or slick roads.