

# **SIDECAR 2003**

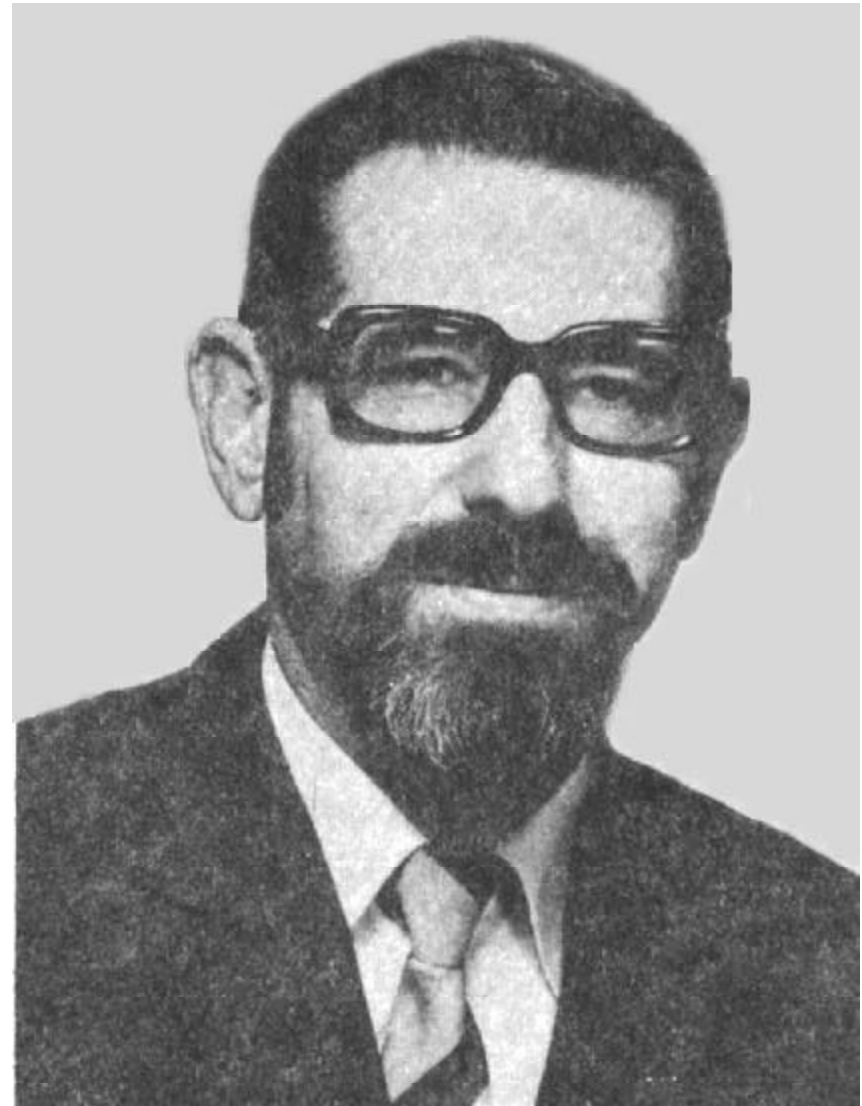
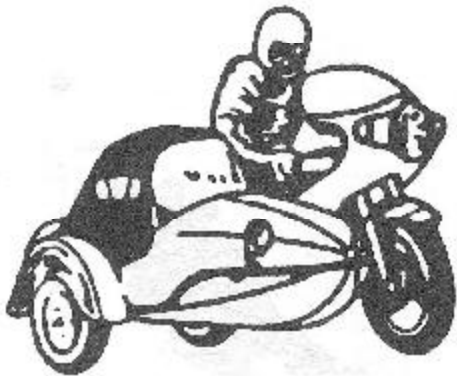

Hal Kendall - Author

Hal built his first sidecar outfit in 1953 in Melbourne, Australia. He has built and driven many outfits in Australia, the US, and the UK

SIDECAR

## PREFACE

In any generation there are always a few not content with the mundane. They want to get away from the norm and want to conquer the unconquerable. These individuals are not content to be enclosed in a stuffy metal enclosure. Nor are they satisfied with the exhilaration of a two-wheeler. They ride these three-wheeled unmanageable eccentric machines whose origins begin with the birth of the mechanical horse. Sidecarists are held together by the brotherhood of friendship that extends across the nation and around the world.

Little has been said about the theory of sidecaring and its operation although many myths and backyard gossip abound. This manual is for those hardy souls who wish to understand their cantankerous machines in greater detail and to those who wish to join our ranks.

This manual has been compiled as a service to all sidecarists by the United Sidecar Association, Inc. All work was contributed voluntarily beginning with a zero budget. Donations received from the first limited edition manual were set aside to allow for future publications.

If you have additions you would like to consider adding to this manual, please send it to:

hkendall@houston.rr.com

H. A. Kendall, Ph. D., Co-Founder, Past President, and past Executive Secretary, USCA, Inc.

SIDECAR

## DEDICATION

The United Sidecar Association Sidecar Manual is dedicated to the many greats of sidecaring, those who made it all happen, individuals and manufacturers alike. Sidecaring covers several generations, having its debut in 1903. The United Sidecar Association, Inc. boasts several senior citizens, each with over 70 years of experience.

This Manual would not be possible without the many dedicated sidecarists, professionals, sidecar manufacturers, and other sidecar enthusiasts. They contributed articles or photographs and reviewed the rough drafts. Every effort was taken to ensure technical accuracy. The final manual represents the consensus of opinions of many experts.

A special round of applause to Lee Kendall who spent many long hours at the typewriter, writing letters requesting information, preparing the rough draft and the several drafts prior to delivering the finished copy. The best selection of available technical and informative knowledge on this subject is contained herein.

Last, but not least, all members of the United Sidecar Association share the credit. Without your loyal support and confidence in my abilities, there would have been no manual. I fitted the pieces of the jig-saw of information you supplied into a somewhat logical fashion.

A few of the contributors or commentators to the original Manual and the revised Manual include Dorde Woodruff, Ron Rennie, Frank Zuck, Thomas Pederson, David Hough, Doug Bingham, Jim Dodson, and others too numerous to mention.

This fourth edition is the result of your many requests for MY Sidecar Manual. Much has happened since the First Edition and this Manual expanded in several areas. Some sections are compressed and treated more fully in the Sidecar Operator Manual.

A Sidecar Catalog, available from our Bookshop, describes pictorially over one hundred sidecars currently available on a world-wide basis.

Hal Kendall

## SIDECAR

### All About the USCA

The United Sidecar Association Inc. is an independent organization of enthusiasts who own motorcycles with sidecars attached, ranging from the luxurious Harley-Davidson to the classic Steib, from contemporary Watsonians to futuristic Side Riders, and from racing kneelers to homemade hacks". They are attached to all machines, from the magnificent Harley-Davidson to the humble scooter. The members are varied as their machines, from the youngest in their late teens to our senior enthusiasts in their eighties. The Association began in Chicago in 1976 and spread rapidly throughout the United States and abroad as sidecarists learned of our organization, our expertise, and our ability to speak up for sidecarists on political issues. Our successes include rolling back turnpike toll charges on all turnpikes in the United States for motorcycle-sidecar outfits and the development of Sidecar Instruction Training Programs.

The Sidecarist, the world's most knowledgeable monthly sidecar publication, is written by and for sidecar enthusiasts, and is part of your membership. You will find great variety in the Sidecarist, including articles on driving, alignment, and mounting. There are letters from members, construction features, technical articles, and news of and about members and events. There are sections from local chapters prepared by their directors; and we communicate and work with other sidecar clubs throughout the world. There is an extensive classified section for members where they make known what they wish to buy, sell, or exchange. You also share in sidecar rallies. In short, the Sidecarist keeps you in touch with thousands of sidecar owners.

Everything appeals to sidecar owners, drivers and passengers, as well as sidecar mechanics and engineers. While exchange of technical data is always important in discussions about sidecars, the association's activities encompass many interests. Events include an Association rally, area mini-rallies, local meets, just plain kicking tires, museum tours, and picnics. There is always something happening in the USCA and membership is as enjoyable as driving an outfit.

The USCA keep you informed, it provides you with another view point about sidecaring as it is the largest independent sidecar group in the world. The USCA is an informed club. The members prefer to be without the usual trimmings found in other motorcycle organizations. You will find it refreshing to belong to a group where your ideas are welcome and there is no pressure to be active, but where your participation and help is always appreciated. This informal atmosphere has made the USCA the largest sidecar club and has generated much enthusiasm and interest from the rest of the sidecar world. Membership in the USCA is extended to all sidecar owners, dealers, manufacturers, and enthusiasts.

## SIDECAR

### ABOUT THE AUTHOR

The sidecar operator manual was compiled and edited by Hal Kendall, Ph.D., of Houston, Texas.

Kendall is the co-founder and executive secretary of the United Sidecar Association, Inc. He is also the founder of the International Laverda Owner's Club, and the co-founder, executive secretary, and president pro-tem of the Association Of Jensen Owners.

Hal's association with sidecars spans a half a century. He is a dedicated champion of issues related to motorcycle safety, of bikers rights, and on equality on the nation's tollways for sidecarists. His numerous articles and manuals on sidecaring have been published in England, Australia, and the United States.

Professionally, Hal is currently responsible for training drilling personnel of a major international drilling contractor. His prior activities include working variously for several major international integrated oil companies as a senior research drilling technologist, associate drilling engineer, chief drilling engineer, country operations manager, and chief logistics engineer.

Academically, Hal began with a Bachelor of Civil Engineering w/ Honours from the University of Western Australia, a M.Sc and Ph.D from the Texas A&M University, and a M.Lit. in Natural Science from the University of Pittsburgh, PA.

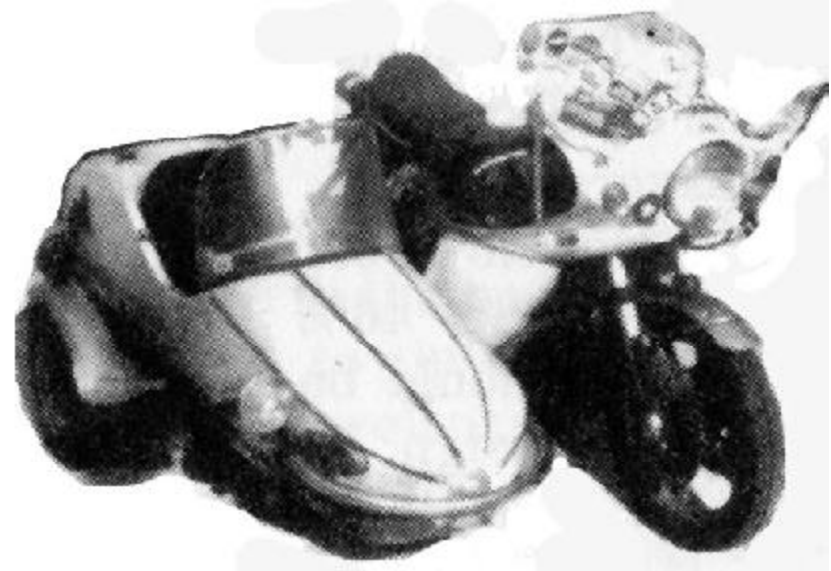

Hal's 1972 Laverda 3C w/ Watsonian GP

Note some of the safety or modified features:

1. Increase rear tooth sprocket from 48 to 52 T
  2. Reduce front tooth sprocket from 19 to 17 T
  3. Add extra width stalks for RH & LH mirrors
  4. Change 123 W alternator for 55 amp auto alternator
  5. Modify upper triple tree to reduce trail to 2-1/2"
  6. Add Fiamm twin air horns w/ on board compressor
  7. Add turn signals front & rear to sidecar
  8. Add driving light to sidecar
  9. Add towball to rear of inner rail of SC frame
  10. Add 5th mount: trailer ball to upper RH rear susp.
  11. Add rear coil suspension to SC body on false frame
  12. Add twin rear gas shocks from SC body to SC frame
  13. Add radio and heater to SC
  14. Install SC drum brake w/ left hand lever brake
- Cruise at 85-90 mph, top speed 105 mph w/ SC unladen.

## TABLE OF CONTENTS

### SECTION 1

#### DEDICATION

#### PREFACE

### I. INTRODUCTION

#### 1.1 Evolution of the Sidecar

#### 1.2 Types of Sidecars

#### 1.3 English vs American and Continental

#### 1.4 Sidecar Histories

##### 1.4.0 Sidecaring in the United States

##### 1.4.1 Watsonian

##### 1.4.2 Swallow

##### 1.4.3 Flxible

##### 1.4.4 Other Manufacturers

##### 1.4.5 Squire

##### 1.4.6 Motorvation

##### 1.4.7 Sidecar Restorations

##### 1.4.8 Equalean

##### 1.4.9 Harley-Davidson

##### 1.4.10 Steib

##### 1.4.11 Japanese Sidecars

#### 1.5 Why a Sidecar

##### I. 5.1 Advantages

##### 1.5.2 Disadvantages

##### I. 5.3 Modern Sidecar Technology

### SECTION 1: INTRODUCTION

#### 1.6 The World of Sidecaring

##### 1.6.1 Clubs and Associations

##### 1.6.2 Newsletters and Publications

### SECTION 2

#### 2. SETTING UP AN OUTFIT

##### 2.1 Matching a Sidecar to a Motorcycle

##### 2.2 Tips for Mounting

##### 2.3 Alignment

##### 2.3.1 Sidecar Wheel Lead

##### 2.3.2 Leveling the Frame

##### 2.3.3 Toe-in Adjustment

##### 2.3.4 Lean-out Adjustment

##### 2.3.5 Wheel Track Width

##### 2.3.6 Reducing the Muscle Work

##### 2.3.7 Alignment Problems

##### 2.4 Frame Supports

##### 2.4.1 Welding on Frames

##### 2.4.2 What Not To Do

##### 2.5 Brakes

##### 2.6 Lighting

##### 2.6.1 Instruments

##### 2.6.2 Running Lights

##### 2.6.3 Stoplight

##### 2.6.4 Headlight

##### 2.6.5 Turn Signals

## SIDECAR

### SECTION 3

#### 3. HANDLING TACTICS

##### 3.1 Advice for the Novice

###### 3.1.1 Getting Started

###### 3.1.2 The Controls

###### 3.1.3 Going Straight

###### 3.1.4 Front Wheel Wobbles

###### 3.1.5 Checking Alignment

##### 3.2 Basic Skills

###### 3.2.1 Right-Handers

###### 3.2.2 Left-Handers

###### 3.2.3 Negotiation of Right-Handers While Accelerating

###### 3.2.4 Negotiation of Left-Handers at Speed

###### 3.2.5 Right Angle Turns

###### 3.2.6 Lane Changing

###### 3.2.7 Braking

###### 3.2.8 Practice

###### 3.2.9 Tips for Handling

##### 3.3 Advanced Skills

###### 3.3.1 Independent Braking Techniques

###### 3.3.2 Lifting the Chair

###### 3.3.3 Rough and Slick Surfaces

###### 3.3.4 Hills

###### 3.3.5 Parking

##### 3.4 Wobbles

##### 3.5 Off Road Riding

##### 3.6 Trailers

##### 3.7 Racing Sidecars

### SECTION 4

#### 4. IMPROVING THE OUTFIT FOR BETTER HANDLING

##### 4.1 Modification of a Modern Machine

##### 4.2 Front End Geometry

###### 4.2.1 Leading Link Forks

##### 4.3 Steering Dampers

##### 4.4 Suspension

##### 4.5 Gearing

##### 4.6 Chains

##### 4.7 Wheels

##### 4.8 Tires

### SECTION 5

#### 5. SIDECAR DESIGN THEORY

##### 5.1 Adjustable Sidecar Trim Systems

##### 5.2 Front End Geometry

##### 5.3 Theory About Turning

### APPENDIX

Sidecar Lists, Manufacturers, Dealers

## 1. INTRODUCTION

This manual is all about sidecars. What is a sidecar? According to Webster, it is a car attached to a motorcycle for a passenger seated abreast of the cyclist. Britannica defines a sidecar as a small, one-wheeled passenger car attached to the side of a motorcycle. A car is a vehicle on wheels so the above definition should suffice.

This simple vehicle gives much concern to bureaucrats. Most States define a motorcycle as "every motor vehicle having a seat or saddle for the use of the rider and designed to travel on not more than three wheels in contact with the ground, but excluding a tractor."

A motorcycle with a sidecar attached is still a motorcycle. The Society of Automotive Engineers defines a motorcycle in a similar fashion.

Why did some States such as Virginia and West Virginia require an additional license for the sidecar? The need for additional revenue, perhaps, or the confusion between adding a trailer and adding a sidecar to a motorcycle. The trailer is NEVER a part of the host vehicle. The sidecar, while it can be removed, is an integral part of the sidecar.

Why did several tollway authorities require a motorcycle with a sidecar to pay a toll 50 percent higher than the toll for a truck or a bus? Rules often make little sense. In this case, the charge is based on "axle" count. A motorcycle with a side-

## SECTION 1: INTRODUCTION

car attached has three definable axles. However, the sidecar wheel is offset in front of the rear wheel by an inch or so, as in many of the earlier H-D outfits, to perhaps 6 or 8 inches. This is mainly for stability on lefthanders. The USCA pointed out to the major tollways that their own equipment was set to allow any vehicle to approach and only a single axle count was recorded even though the vehicle was up to 15 degrees from a head-on attitude. The tollways then allowed all motorcycles with or without a sidecar to be charged for the same rate as a car or pickup.

Why does the National Highway Traffic Safety Administration sometimes require a motorcycle with a sidecar to have a parking brake? They require it of all three-wheeled vehicles, but only if it designed as a three-wheeler. This includes a motorcycle with a sidecar that comes from the factory with a fitted sidecar. But this regulation does not apply if the motorcycle and the sidecar come from the same supplier but is assembled by another party, the motorcycle dealer, for example.

To the beginner without expert instruction, the first ride can be a terrifying experience. In the hands of an expert, the sidecarist can out-manuever many an experienced soloist, given a properly set up machine.

Many have mis-matched sidecars to unsuitable machines and vice versa because reference material is scarce. Some sidecar outfits are mis-



## SIDECAR OPERATOR MANUAL

aligned, some dangerously so. Well meaning drivers offer wrong driving techniques. This manual will address these concerns.

Sidecarists can enjoy their outfits in comfort and safety if they follow the guidelines outlined. The manual also contains an encyclopedic knowledge of and about sidecars for the more serious student.

### 1.1 Evolution of the Sidecar

From the earliest days of motorcycling to the present day, motorcyclists have pondered the problem of transporting their women. Some girl friends or wives endured the agonies of bumpy rides on the back of a motorcycle, sitting on the "flapper bracket" or rear seat. How they got there is another matter for the bikes of those days had not have a clutch nor a gearbox nor even a kick starter.

Others could not be persuaded to ride on the rear of the motorcycle in such an ungainly manner, and for them the designers of the pioneer motorcycles tried several approaches to accomodate them.



## SECTION 1: INTRODUCTION

As far back as 1895, a French newspaper offered a prize for the best idea to carry a passenger on a bike. The sidecar idea took the honors but no one did anything about it. A similar contest took place in the United States. Nothing came of these contests.

### The Motorcycle Trailer

The trailer came first. The lady sat on a comfortably cushioned wicker work seat mounted between two bicycle wheels which was towed behind the motorcycle. This was a very undesirable place to be. The noisy, smoky motorcycle was popping and banging up front. It threw up dust, mud, rocks, and whatever else man and nature paved roads with in those days. There had to be a better



De Dion Tricycle w/ Trailer  
(from Side-Cars, Bernard Salvat)

## SIDECAR OPERATOR MANUAL

way for a loving twosome to share the joys of motorcycling. Besides, it was not uncommon for the bent towbar to break off unexpectedly which led to the motorcyclist turning his head to one side and asking "Are you still there, dear"? and added to the apprehension of the damsel.

### The fore-car

They next tried the fore-carriage, or fore-car.

This was another comfortable wicker seat slung between two wheels attached to the front forks. It replaced the front wheel. At least the intrepid passenger could see where she was going even if the driver could not. The driver had to move his head to look around the passenger, thus compromising safety.

It left a lot of room for improvement, including protection from the elements, nature, and the road ahead. Besides, the flimsy front end carriage section often broke.

### The Rear-car

Another short lived solution was the rear-car. It was another three-wheeled vehicle but with two wheels at the rear and a central front wheel. They had a rear differential and could maneuver properly. The rear passenger sat facing rearwards. The vehicle would flip rearwards when fully loaded and going up a steep hill.

## SECTION 1: INTRODUCTION

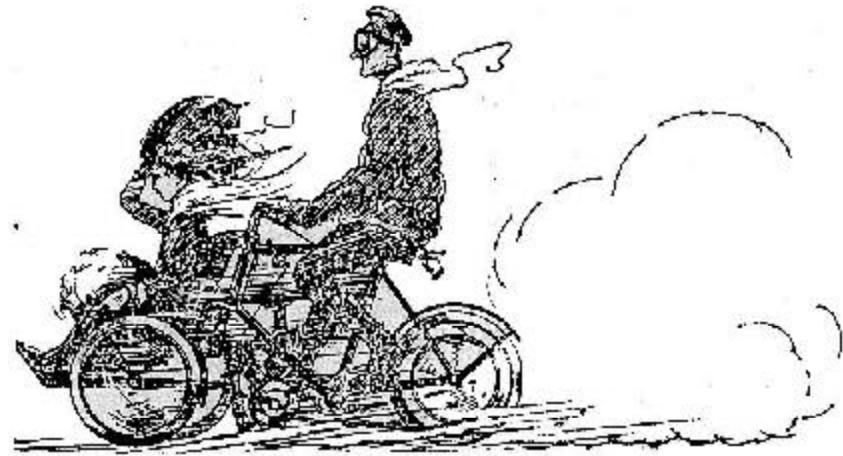

Picture the conduct of this colossal *chapeau* at forty miles an hour.



## SIDECAR OPERATOR MANUAL

The problem of enjoying these new motorcycles weighed heavily on the minds of the pioneers. The three-wheelers were more affordable than motor cars, and a passenger was possible. The January 7th issue of "Motor Cycle," 1903 contained a cartoon on the topic.

Cartoonist George Moore facetiously suggested more togetherness by removing one trailer wheel, and attaching the vacant stub to the cycle frame. The Graham Brothers of Enfield, near London, didn't see the joke. They built and patented their first sidecar, wicker-work and all, in just three weeks. Exactly as in Moore's cartoon sketch.

The lady, now seated in a wicker basket alongside the motorcycle, had more protection. This new outfit required less of a Herculean effort to steer. Sidecars had arrived.

The Grahams sold their rights to Components Ltd., the parent firm of Ariel Motorcycles. Their first production sidecars, known as the "Liberty Sociable Attachment," came from the famous Selly Oak Plant. They soon had many competitors in this field.

Other solutions tried included the Duadcar by Mills Fulford. This design could function as a sidecar or as a fore-car. It could even be built as an oddity, the "Carpeviam Motor Sociable." This was like a car but with two wheels on one side, and the third wheel midway on the other side. The driver and passenger sat side-by-side.

## SECTION 1: INTRODUCTION

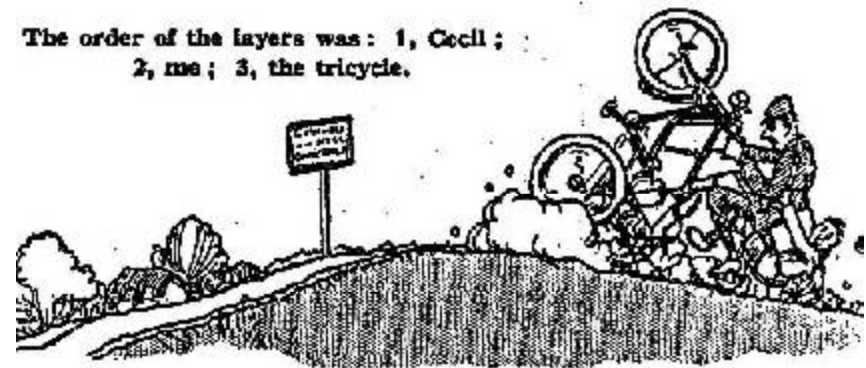

From p 55, King of the Road. Original art from "the Girl of the Period Miscellany" in May 1969. In the British Museum.

## SIDECAR OPERATOR MANUAL

Mr. Wakeman illustrates his concern for women in those days. He made a pedal equipped trailer, remarking "What is a fellow to do when he takes a lady out for a ride and his engine breaks down?" Was she to pedal him home?

The motorcycling community knew they needed a third wheel but were unsure where it should be. Brown Brothers of London hedged their bets. Their 1906 catalog illustrated a fore-car for their 3-1/2 hp motorcycle at \$200, and a sidecar for the same machine at \$190.

The "Lagonda Tricar" and the "Scott Sociable" evolved in 1910. Similar to the Carpeviam, with two wheels on one side and one on the other side. Features included a steering wheel and water cooling. They did not last long.

Scott developed the famous water cooled Scott Squirrel two-stroke twin motorcycles of the 20's and 30's; and Logonda soon became known as the builder of the famous Lagonda Sport's Car of the same era. The Lagonda recently reappeared as a genuine 180 mph full four seater sports sedan.

The sidecar proved the lighter and cheaper solution. It challenged other types of three-wheelers for nearly a decade, finally winning the contest. The competition disappeared and left the sidecar supreme.

Like the automobile, motorcycles and sidecars went through a very intensive development peri-

## SECTION 1: INTRODUCTION

od. The popular layout had the sidecar frame mounted on the curbside. The driver had maximum visibility for overtaking, and the passenger had maximum safety. In America and on the Continent, the sidecar is on the right. In England, Japan, and Australia it is on the left. It is usually permissible to operate with the sidecar on any side you please. England is one country where the sidecar must be on the left. Australia is another.

This manual, while it generally addresses right-hand mounted chairs, is equally applicable to left-hand mounted chairs. Just mentally switch your right hand and your left hand perspectives.

Many sidecars in use in America come from England or Europe, but few American sidecars go outside the United States. The American market rapidly absorbs locally built light and middle weight chairs. The only American sidecar combination, the Harley-Davidson, enjoys popularity outside the United States. Harleys are in many countries in small numbers.

I have driven right-hand sidecars in the United States and in England and also left-hand sidecars in Australis, England and in the United States. It makes no difference on which side you hang the chair if you alter your riding style and habits to the limitations of the outfit. Always slow down when turning towards the sidecar. Failure to bring yourself into harmony with your machine will have predictable devastating consequences.

European and American sidecar styles are similar. You will find classic designs and new innovations on both sides of the Atlantic.

## 1.2 Sidecar Histories

The history of sidecar manufacturers reveals the sidecar heritage. Hundreds of different makes and models have faded from sight but some have left their mark. Many well known car manufacturers began by making sidecars. A few coach and bus builders had a similar start.

Flxible Grumman, one time the world's largest manufacturer of flexible sidecars, now builds buses and luggage lockers. They never let their stockholders and workers forget their proud but humble beginnings as sidecar manufacturers. On the other hand, Harley-Davidson now considers their sidecar as just "an accessory item," perhaps aided by the US DOT.

## 1.3 Sidecaring in the United States

Sidecaring began in America, as in many other countries, just after the turn of the twentieth century, and for the same reasons. The motorcycle could not accommodate a passenger while the motorcar was beyond the reach of the average person.

Sidecaring was popular in the early days with many manufacturers in the trade. Most faded from memory. Their popularity declined as

inexpensive transportation such as the Model T Ford and the later Model A appeared. There were very few sidecars on the highways in the United States from the early thirties until the late sixties.

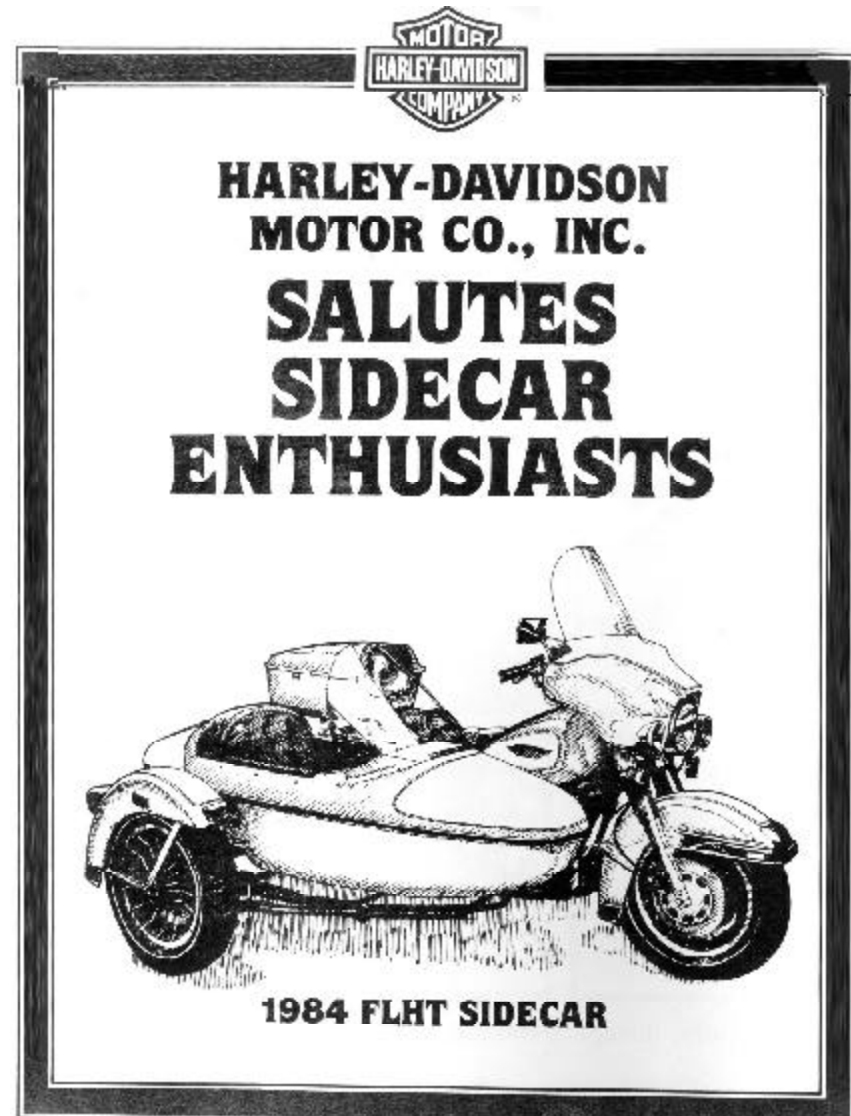

## SIDECAR OPERATOR MANUAL

Only Harley-Davidson continued to make sidecars from the pioneer days to present.

The sidecar revival began in the late sixties with the growth of motorcycle popularity. The International appeared briefly in Minnesota. The Side Strider by Doug Bingham, made its appearance in 1968. Frank Thompson Zuch introduced his Cyclecar in 1971, while the Spirit Eagle came in 1972. Their sidecars had many things in common. They were lightweight (100 to 140 pounds) with universal mounting systems. They cost between \$300 and \$425 and were suitable for the lighter bikes of that era, such as the bikes from the UK and from Japan.

Sidecar popularity grew in the early seventies as manufacturers promoted their products. Several articles of and about sidecars appeared in motorcycle journals and periodicals. Over 100 sidecar outfits gathered at the first Griffith Park Sidecar Rally sponsored by Doug Bingham in 1971. This Rally continues today at the same location with up to 500 outfits in attendance. The sidecar returned as practicable vehicle for the small family. The popularity of the sidecar attracted many entrepreneurs to this field.

A partial list of US sidecar manufacturers, past and present, includes-

1973- Simon (now the Motorvation Sypder) .

1974- HitchHiker

## SECTION 1: INTRODUCTION

Goodwin

\*Centaur (later revived as the Zephyr).

\*American Easy Rider.

\*Freedom.

\*Cycle Mate.

1975- \*Essix.

\*Vetter Terraplane.

1976: \*Cycle Camper.

1977 : Kenna (by Automarket) .

Spyder T-I (by Motorvation).

Coupe Royale (by Motorvation) .

1978-\*Equalean (by Wallick).

\* These models are no longer in production.

Few manufacturers prepared themselves for the serious struggle to produce a long lasting product. They did not survive the economic recession of the mid seventies. Manufacturers now face the increasing complexity of dealing with governmental regulatory bodies and stringent warranties. They must ensure the absolute safety of their products. Some encourage training programs.

We look to continued interest, sales, and the use of sidecars. We also look to suitable sidecar training programs as interest continues.

### 1.3.1 The Flxible Side Car Company

Just a few years after the invention of the sidecar, Hugo D. Young obtained a motorcycle sales agency in Mansfield, Ohio. If he allowed the sidecar wheel to tilt as the motorcycle tilted when turning, he could take curves faster and safer. The sidecar would attach with flexible connections. This invention would also allow the wheel to rise or fall over uneven ground while keeping the sidecar level.

Mr. Young made a flexible unit in 1912 for his own use. A traveling salesman friend suggested he obtain a patent. Seeing commercial possibilities, he suggested manufacturing the device. That patent inspired the "knee-action" design found in later automobile suspension systems. Carl F. Dudle joined Young in 1913 as a partner in the Flxible Side Car Company. Patent disclosure dictated the unusual spelling. They incorporated the company in 1924.

The Flxible was an improvement over conventional sidecars and soon became a favorite of many sidecarists, notably for sidecar racing.

All major sidecar racing records soon fell to motorcycles equipped with Flxibles. These sidecars fitted Harley-Davidsons, Thors, Hendersons, Indians, Reading-Standards, and Excelsiors. They sold Flxible's to dealers and individuals. Many went overseas. The company built its own factory in 1916. It soon became the world's largest exclusive manufac-



The flexible Flxible knee joint allowed the sidecar to remain level while the motorcycle rider tilted to make a turn. (Flxible Co. Photo)

turer of sidecars. The single seater with a door was the most popular model. They also had a side-by-side two seater, and a convertible top model.

During World War I, they only made olive drab sidecars to fit Excelsior Motorcycles for use by the Allied Armies. The sidecars went to New York for shipment overseas. On arrival, they were uncrated, fitted with a machine gun, and attached to the motorcycle. They were very fast, and an efficient means of destruction in combat areas.

They deleted the word "sidecar" from their name in 1919 to reflect potential diversification. The cost of the Ford T dropped as the result of the depression. Now it competed, dollar for dollar,

## SIDECAR OPERATOR MANUAL

against the motorcycle and sidecar. The popularity of the sidecar outfit declined while the popularity of the T increased. The Flxible Company moved from the sidecar trade into coach building and the rest is history. Rohr Industries of California purchased Flxible in 1970. The Gruman Corporation bought Flxible four years later. Today, millions of Americans travel daily in Flxible buses. While viable, the Company never lost sight of their humble beginnings as a sidecar manufacturer. A Flxible Sidecar appears just a page or two ahead of their modern buses in a recent company brochure.

The last word:

1995: Last Flxible bus produced.

1996: Flxible files for bankruptcy, assets auctioned.

### 1.3.2 Motorvation Engineering - California

The company made Jerry Simons' Spyder T - I, and Ed Millray's Coupe Royale in 1976. Jim Sonntag purchased the company in August, 1979. The Roadster Royale, a convertible version of the Coupe Royale, came in 1980. The Formula II made its debut in 1981 using an exclusive patented adjustable lean-out device by pre-loading the suspension.

Popularity of the Formula II outstripped production of other models from 1983 to 1987. They

## SECTION 1: INTRODUCTION

returned, by popular demand, with an improved external frame. The heavier models included an adjustable suspension. They offer a wide range of sidecars with quality fittings and mountings, and a Back Pack cargo trailer. The trailer is towed behind a solo motorcycle or a sidecar outfit. Special motorcycle sub-frames are available.



Mr. Arnold's  
GL1500 w/  
Motovation II  
and Trailer  
Motorvation  
Engineering  
Sidecars and  
Trailers  
941 Fourth Ave.  
Sibley IA 51249  
712.754.3664  
800.305.3664



## SIDECAR OPERATOR MANUAL

### 1.3.3 Prestige MotorSports, LLC, formerly EML St. Louis

Robert Odell and William Heggarty founded Sidecar Restorations, Inc. in 1970. Heggarty's outfit, a 1966 BMW with Steib TR 500 sidecar, created widespread interest. The two teaching partners spent their summers in Europe on motorcycles. They looked for old sidecars for restoration and resale. This business soon mushroomed into a full time venture. The Company moved into larger quarters on several occasions. Brian Casey later joined the organization.

They imported EML sidecars, kits, and complete outfits from Holland a few years ago. The new company name reflects the success of this venture. EML of St. Louis is the sole United States importer for EML. They have a small dedicated dealer network. They install one half the sidecar units imported while their dealers install the rest.

A related company, BMW Motorrad of St. Louis, is the largest BMW dealership in the world. They operate the largest paint facility for BMW motorcycles outside the BMW factory. Their specialty is applying BMW paints to any BMW part, including complete motorcycles. They carry a huge inventory of BMW parts and support a toll free parts order phone line. They stock mounting sets for all popular BMW models. Universal hardware is generally available for all makes of motorcycles.

## SECTION 1: INTRODUCTION

Those wishing a classic style sidecar or inexpensive transp, or may choose the Ural imported from Russia. This is a good buy in sidecars. It is solid, a copy of the civilian version of the WW II German military sidecars.

As Sidecar Restoration, they restored over 400 Steib sidecars. Several were re-exported back to Germany. Restoration continues as part of their operation. At least one restoration project is always in progress. Many Steib parts are always on their shelves.

For prices, pictures, or more information, call or email [Bob Odell](mailto:Bob.Odell@motorrad.inlink.com) at [motorrad@inlink.com](mailto:motorrad@inlink.com).

4011 Forest Park Boulevard

St. Louis, Missouri 63108

314-531-4010

800-999-1269





Steibs, Courtesy SIDECAR, OZ HOUSE, JAPAN



## SECTION 1: INTRODUCTION

### 1.3.4 The Equalean - California

Leaning sidecars have been around since 1903. In the hands of a professional, they outperformed a conventional rigid hack.

P.C. Harrington Johnson built his own rig in 1932 from scrap. He used a picture of a Harley-Davidson banking sidecar as a model.

"We had enormous fun with it on the road. It was a real delight to sail up to a Bobby on point duty (traffic cop), stick out your right hand at a quite impossible speed, grin at his horrified gape, and chuck the whole outfit on its right ear (left hand chassis) as [ou scuttled round the corner...all three wheels banking at an impossible angle as you went around at solo speed. It did not work quite the same to the left and the "independent springing" effect of the sidecar wheel made the light chair hop skittishly over bumps and into potholes.

"The setup did have two serious difficulties...you had to park it offside - on to the kerb, propping the footrest on the pavement as the outfit would not stand straight by itself; the other was that the darned thing skidded just like a solo over wet tramlines (trolley car tracks). The outfit was not really intended for serious sidecar passenger carrying...the passenger had to sit very still, bang in the middle, and let the bike and sidecar wheel lean round him, which was rather unnerving."

(From Motorcycle Sport, November 1978)

Waly Wallick developed another way to pilot an outfit like a solo. His patented linkage allows hands-off driving, with or without a passenger. An Equalean outfit can lean in curves to the right or the left within allowable lean limits. The independent linkage transfers few stresses to the cycle frame. This is good news to those with late model machines designed for solo operation. Such machines may have light frames not suitable for heavy duty sidecar operation.

Wear on the sidecar tire is about the same as for the motorcycle front wheel. Gas mileage drops by only two or three mpg. The outfit handles equally well whether loaded or not. No ballast is necessary for an empty sidecar. Turning requires little effort.

No changes required in the steering department. Heavier front fork oil and possibly air caps are desirable. The sidecar requires only minimum effort to mount or de-mount. Alignment is nearly automatic.

The future of this machine depends on the sidecarist. Does he wish to operate his outfit in a manner similar to his solo bike, or does he prefer a rigid machine?

The Equalean was available from the Jamison Fabrication Company of California. It is no longer available.

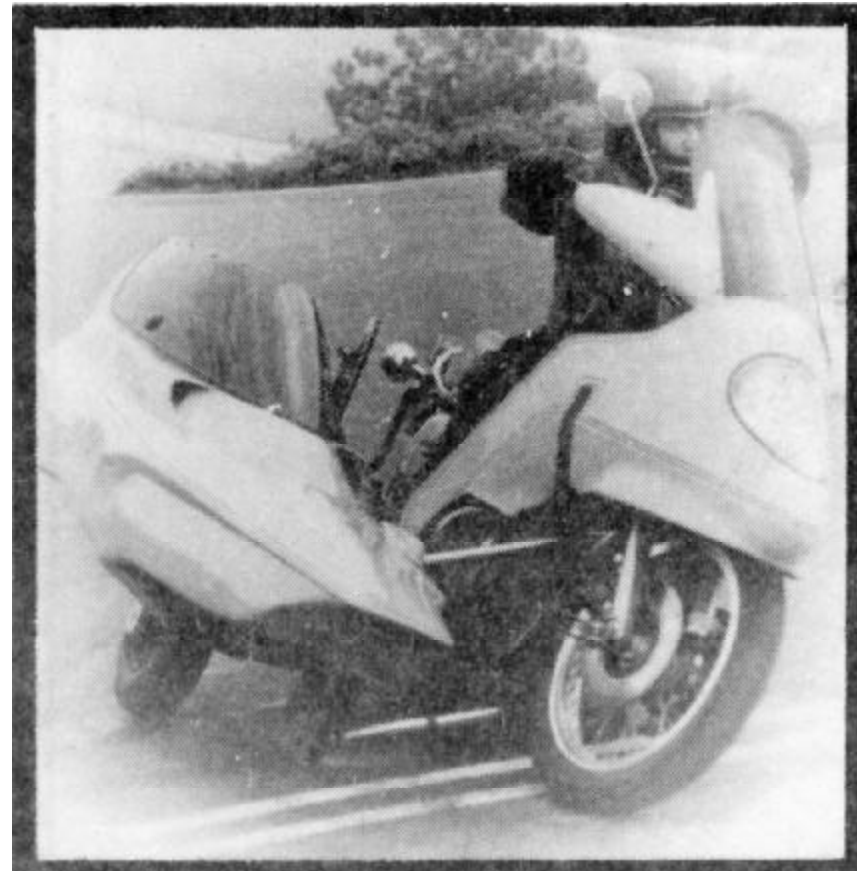

The Equalean - Now Discontinued

Note: these bikes have made comebacks from time to time. In the hands of an expert they can be formidable. They have been used for professional racing and also banned from racing. Some required that the degree of banking was dialed in by the monkey.

### 1.3.5 Harley-Davidson - United States

The earliest sidecars fitted to Harley-Davidsons came from Flxible and other sidecar manufacturers. Sidecar history is scarce from 1903, the year the factory started, until 1919, when Harley-Davidson made sidecar models for military use.

The H-D factory made sidecars. The Seamen Body Company also made sidecars for H-D. Some 3257 sidecars were sold in 1924, or 1 for every 2 V-twins sold that year. One Indiana dealer purchased 41 V-twins, all except 1 sidecar equipped.

A pointed nose graced the 1930 sidecar for 74 model motorcycles. The sidecar featured interchangeable jiffy wheels, and an internal expanding sidecar wheel brake used with the rear brake. It had semi-elliptical springing as standard equipment. Twin headlights were available for the motorcycle and the improved electrical system included an automatic voltage regulator.

The 1929 Enthusiast, the factory news journal, reminds sidecarists to adjust the connecting bar so the motorcycle leans slightly away from the car (or truck) body. It is wrong for the motorcycle to lean toward the sidecar. With the connecting bar properly adjusted, you will not feel any side pull. The basics of sidecaring remain the same today.

The 1929 Enthusiast also tells how two young Chicago girls drove from Chicago to New York, then from Chicago to the West Coast and back to Chicago on a Harley-Davidson outfit.



Early 1920s: William S. Harley on H-D, William A. Davidson in SC in New England. They crashed the rig on a freshly oiled hillside road. Harley gashed his head. Davidson suffered a broken kneecap.

From the W.A. Davidson Collection

Grocery package Harley-Davidson trucks were quite common, according to the photos in the Enthusiast. The 1933 Harley-Davidson Package Truck, Model MXP, and the Servi-Car were given a substantial price reduction.

The basic Harley-Davidson now cost less than a 1914 Harley-Davidson. They sold the machine without electrical systems or lights, no footboards, small tires, and a two speed transmission. It delivered only 8 hp. The 33-LS sidecar for the 45 cost only \$90 while the 33-LT sidecar for

## SIDECAR OPERATOR MANUAL

the 74 cost just \$15 more. The former had coil suspension up front. A full combination sold for a modest \$415.

An OHV 61 joined the Vee twin line-up in late 1936, while an 80 SV became top of the line. The 45 and the 74 continued in production.

The three larger engines used roller bearings in their flywheel assemblies. The needle pointed sidecar gave way to a pleasing round nosed sidecar, their basic style for the next thirty years.

Sidecars and Servi-cars were assembled in the top floor of their extensive ten-acre floor space factory.

William Connelly, A.M.A. Commissioner of District No. 4, with co-pilot Fred Dauria, captured the transcontinental sidecar record. They completed the 3300 mile run from New York City to Los Angeles in only 69 hours, 46 minutes in 1936 on an 80 Harley-Davidson outfit. At no time was the engine stopped for more than 8 minutes at a time during this period. Over one million people who attended the opening of the Boulder Dam saw these pioneers who were guests of honor at the ceremony. Their return home was more leisurely and included many vacation stops and a visit to the Harley-Davidson Factory.

H. Persoon won the International Six-Day Trials in 1936 on a 61 OHV outfit. His passenger was V. Ripel.

## SECTION 1: INTRODUCTION

Harley-Davidson produced the FLH Classic Sidecar to celebrate their 75th Anniversary. Their famous 80 1340 cc V-twin engine, rated at 80 hp, powers the unit. Fork trail reduction improved maneuverability. Increased total gearing retained good acceleration. The three interchangeable die-cast wheels come with MT-90-16 tires. The FLH is two-tone tan and cream with hand applied pin striping.

William A. Davidson, Vice President and a founder of Harley-Davidson, passed away on April 24, 1937. William S. Harley, the founder and Chief Engineer, passed away in September of 1943. Arthur Davidson, the remaining founder of the Company, died in an automobile accident on December 30, 1950. He had served as Secretary and General Sales Manager. Walter Davidson, Founder and President, passed away in 9/1973.

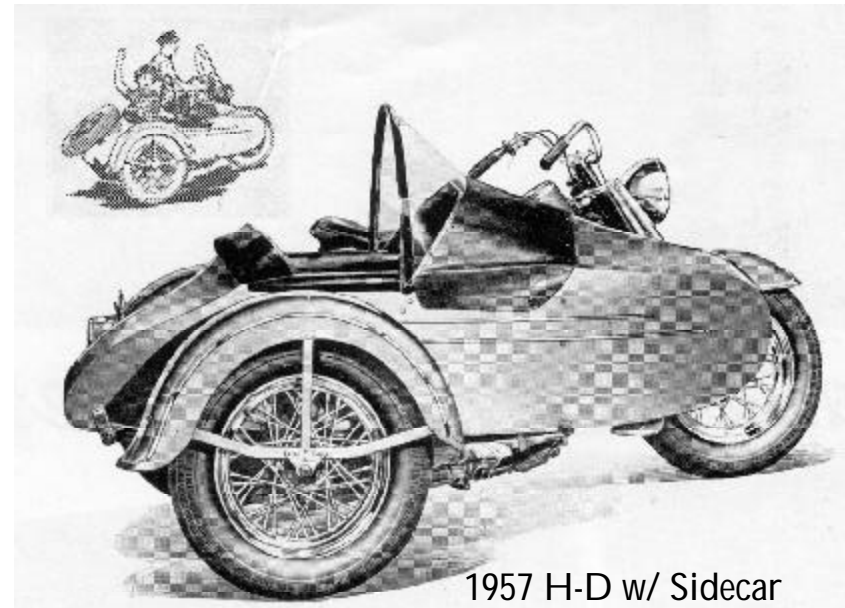

1957 H-D w/ Sidecar

## 1.4 Sidecaring in England

As mentioned, sidecaring began in England just after the turn of the century. It is fitting that the history of English sidecar manufacturers begins with Watsonian. Several British sidecar manufacturers in recent prominence include Heddingham, Gemini, and Saluki. The Wessix, well known in the mid fifties, faded, returned, and faded yet again. Only Watsonian, Squire, and Heddingham continue making sidecars today although others have joined recently.

### 1.4.1 Watsonian

Of all sidecars, this name conjures up stability of sidecaring throughout the world and is a household name for many sidecarists. Not the first manufacturer, nor the largest, nor perhaps even the most progressive, yet Watsonian remains a major manufacturer. They produced sidecars in 1912 and continue to produce sidecars today.

Watsonian is the only surviving manufacturer who went into business to produce sidecars over 90 years ago and continue to do so today.

The Watsonian era began with a 26 year old humble carpenter, Thomas Frederick Watson. Thomas and his bride lived in a terraced three storied house in the elite Conybere Street of Balsall Heath, Birmingham. Thomas, an avid road rider, owned a NSU Twin. He faced a difficult and irksome prob-

## SECTION 1: INTRODUCTION

lem. Each time he wished to take his wife for a spin he would wheel his bike through a narrow passageway between the houses. Then he dragged his sidecar down the passageway. He then attached the sidecar to the bike. Upon returning, he would reverse the procedure.

A jack-of-all-trades, he experimented with collapsible cardboard shoe boxes. He then built a collapsible sidecar which would pass through a 32 inch wide opening, yet expand into a rideable street sidecar.

On July 9, Ronald George John Watson, later to become chairman of Watsonian Ltd., was born. Thomas created the "Patent Collapsible Sidecar Company" that year as many asked for a similar chair.

There was little room in Birmingham to stable outfits. The company went "Ltd." in 1912 and renamed the "Watsonian Folding Side-Car Co., Ltd." in 1913. The first folding chair, the Monarch, was also available with a conventional rigid chassis. Watsonian's second model, the "Colonial Cabriolet" featured a spare two-gallon petrol tank in its nose.

Fourteen sidecars showed at the 1913 Olympia Show, including the Montgomery and the Fulford. Only Watsonian remains in the business of sidecaring. While Thomas brazed the components together in the kitchen and mother sewed the cushions together, Ron began learning the sidecar trade.



Watsonian Cambridge



Watsonian Oxford



Watsonian Jubilee

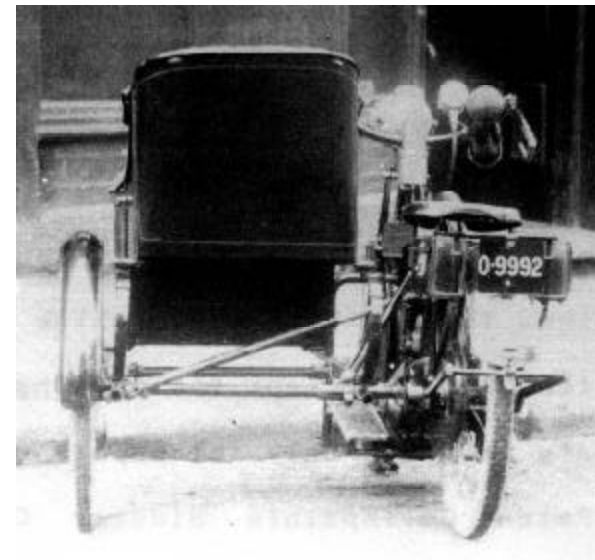

Watson's Collapsible Sidecar - 1912

## SIDECAR OPERATOR MANUAL

Larger premises became available in 1922. Unfortunately, they burned from a spark from a passing train in March 1930. The next year Fred moved to still larger premises in Albion Road, Greet, where the company continues today.

In 1926, when the General Strike brought near financial disaster, Fred bought out the Kwikfit chassis. This remained their main product until the introduction of their small wheeled chassis in 1954. Ron also entered the Watsonian business that year and soon became the chief tester for racing and competition hardware. Ron was an avid scrambler and participated in National and International trials.

Sidecar production halted temporarily for the war effort as Watsonian produced rucksack frames, officers beds, portable aircraft hangars and flares. Thomas died a year before the end of hostilities and Ron, at 33, took over the factory.

Post war competition was fierce. Eighteen companies produced sidecars with Watsonian making fifty percent of total output.

Other manufacturers were Busmar, Swallow, and Canterbury. Watsonian took over the Swallow production in 1956 and parts for some Swallow models are available from Watsonian.

Watsonian continued activities in racing and competition. They made racing outfits for the best drivers, including world Sidecar Champion, Eric Oliver.

## SECTION 1: INTRODUCTION

The small wheel development for street hacks in 1954 took advantage of the lower center of gravity of the sidecar, a racing development. A strong chassis and a more robust suspension ended structural problems. Watsonian introduced the Kenilworth and the Maxstoke Saloon, both in two seater configuration. The semi-monocoque body also came from racing. The glass-fibre made pleasant curves and sweeps easy to design and build. More significantly, it lowered production costs when steel and wood construction costs were becoming significantly higher.

In the mid fifties, the peak of sidecar production in England, Watsonian produced about 200 units a week. Total estimated annual production was 20,000 sidecars for England. Only about 5 percent went to the export market.

By the mid sixties, Watsonian was the only sidecar manufacturer in England - all other competition had lost out to the Austin Mini.

Watsonian, although producing 17 models, sought other markets. They produced thousands of reinforced polyester/glass Bambini sidecars and Bambox commercial side boxes for motor scooters. They expanded into hard tops for MG sports cars, side panels for BSA motorcycles, and dodgem cars for fun fairs. They made children's miniature four wheel one- and two-seater cars with engine sizes up to 120 cc. They also made road signs, drying "horses" for curing saddles, and petrol tanks for the BSA. They expanded and



produced trunk extensions for BMC, and head rests for the Rover 2000. Sidecar production still accounted for about one-third of their total production. In simple economics, it was diversify, or fold.

Watsonian weathered the storm and still produce the Monaco, a single seater with lockable trunk. Other favorites include the Palma, a child-adult version of the Monaco; and the Monza, a super sports single adult. The Monza is an updated Flight. The Grand Prix, another favorite, is a single seater sports version. A recent development is a larger unit based on an improved and strengthened Super Silk chassis. The Oxford can seat three or four adults. The Cambridge, on the same chassis, has a full double bench seat that seats two and includes a spacious trunk.

The stability of Watsonian is exemplified in their employees. Employees who spent their lifetime with the Watsonian company include Charlie Watson, Thomas' brother; G.C.Bennett, Managing Director; Wilson Griffiths; Albert Milner; and many more.

Ron Watson and Cliff Bennet retired leaving Cyril Heath and Peter Machin as Directors. The company moved to newer, smaller premises at Blockley. Joining them as Director and United States Distributor was Doug Bingham, owner of Side Strider and past President of the USCA, Inc. The firms of Watsonian and Squire merged in 1988 to become one of the largest sidecar manufacturers

in the world. With the recent revival in sidecars, Watsonian-Squire is in an enviable position to capture word markets. They later merged with Squire Sidecars, see below.

### 1.4.2 Squire Sidecars-(Bushfield Ltd.),Warwickshire, U.K.

The company, in 1972, restored Rolls Royce Silver Ghost's and other vintage cars. Diversification in 1974 resulted in a high quality single seater sidecar for modern motorcycles. Sidecar interest grew with their first model release in 1975. Sales doubled each year until they became the largest sidecar manufacturer in Europe making over 1000 sidecars each year. Export sales account for nearly 70 percent of production. Squire distributors are in most European countries and account for nearly 70 percent of production.

Their current catalog illustrates 10 different models including dual width sidecars, trailers, and cargo side boxes. They have special contracts with several countries, including Egypt, Nigeria, Canada, Japan, and Kuwait. Their premature introduction to America failed as liability insurance difficulties became insurmountable. Their acceptance in America may change with their link with Watsonian in 1988.

### 1.4.3 Swallow to SS to Jaguar

The makers of the humble Swallow sidecar, produced after World War I, can be justly proud of their offspring, the Jaguar racing and saloon cars. William Walmsey, son of a wealthy coal merchant, made the first Swallow sidecar. William had no interest in his father's coal business. He preferred to buy and renovate war surplus Triumph motorcycles.

The Swallow had sporty lines and a comfortable passenger seat. Aluminum panels on an ash frame enclosed the octagonal Zeppelin-like body. A polished aluminum disc on the wheel enhanced the sporting image. A touch of luxury was the close fitting coupe top which reduced visibility to nil. Walmsey turned out one unit a week, making almost everything himself. His sister did the upholstery and trim, later done by his wife. The chassis came from Haldons of Birmingham. The price of the sidecar was thirty two guineas or about one hundred and thirty five dollars.

Mr. Walmsey Senior sold his coal business in 1920 and the family moved to Blackpool. William's sidecar manufacturing continued at the same leisurely pace at the new residence. Mr. W. Lyons lived nearby. His piano business held no interest for his 20 year old son. William Lyons, Jr. was an enthusiastic motorcyclist who took part in many competitions and sprints on the nearby Southport Sands. The sporty lines of Walmsey's sidecar appealed so he bought one.

## SECTION 1: INTRODUCTION

William Lyons saw a future in the Swallow sidecar. They could market them economically if they could make ten a week. They waited a few weeks for Lyons to come of age, then floated the Swallow Sidecar Company with \$4,000 capital. Operations moved from the Walmsey's garage to a small factory nearby. They employed a staff of twelve.

Swallow sidecars were raced at the 1924 Isle of Man TT with Harry Reed finishing second on a 344 cc Dot-JAP-Swallow. Tinkler brought a Matador-Blackburn with Swallow chair into third place. Reed remained loyal to Swallow in 1925, though he changed to a Matador motorcycle. A lighter sidecar model intended for competition grew out of this racing activity in 1925.

The expanding company moved to larger premises in Blackpool the following year and now employed thirty people. The Nottingham Police purchased several Brough Superior motorcycles fitted with Swallow sidecars in 1927. A new chapter in the Swallow story opened when they produced the first Austin Seven Swallow two-seater car in 1927. It had a podgy looking body fitted onto an Austin Seven chassis. This started them on the road to auto world glory and away from motorcycles.

The sidecar business carried on for a time. They built a universal chassis for mounting on either side of the bike for left- or right-hand drive. This unit sold very well in Switzerland. A launch style body came in 1928 which avoided the fabric covered body made popular by Weymann.

## SIDECAR OPERATOR MANUAL

Speedway racing, popular in Australia, came to England in 1928. Swallow then added a speedway sidecar to their range.

Cars took over the Swallow factory in the thirties while sidecar construction took only a small section of the factory. Their models included the Standard Swallow of 1930, the elegant SSI and SSII of 1932, and the sporty SS Jaguar i00 in 1936.

They still produced about 100 sidecars a week until the outbreak of World War II. During World War II, Swallow supplied large numbers of box sidecars to all three services and the National Fire Service.

After World War II, development of the SS Jaguar or Jaguar continued. This produced a succession of models from the Le Mans winning C and D Types to the XKE models, to the current XJ's. The Queen knighted him to Sir William Lyons in recognition of his contribution to Britain's export drive.

They sold Swallow Coachbuilding in 1945 and the assets were transferred to the Hellewell Group factory at Walsall. The Group built American light aircraft here under license. Tube Investments purchased Swallow in 1948 and sidecar production continued at the same factory.

Introduction of the Swallow Gadabout scooter, with a 125 cc Villiers engine, came in 1948. An option included a commercial sidecar box. They

## SECTION 1: INTRODUCTION

ceased production prematurely in 1951, just four years before the Scooter boom hit Britain.

Cars were re-introduced with the Swallow Doretti in 1954. It used Triumph TR-2 mechanical components. Competition from the cheaper and faster TR-2, and the Austin Healey 100, soon brought production to an end in March, 1955.

The Walsall Factory continued building sidecars. In October 1956, Watsonian Sidecars purchased Swallow Coachbuilding and transferred operations to their Factory in Greet, Birmingham. Production of this sidecar line ceased in 1967.



Swallow Sidecar

### 1.4.4 Montgomery Sidecars

The Motor Cycle published an illustrated description of a sidecar with options of electric or acetylene lighting in their November 1922 issue. Montgomery's of Coventry made the chassis. They also made complete sidecars. In 1924, they switched to a pentagonal body shape and brought the price of the lightweight touring model down to ninety dollars. The Coupe-de-Lux with hammock seat, Triplex screen, and a luggage compartment in the pointed tail sold for one hundred and twenty dollars.

They proudly displayed their own sidecars on their own stand at the 1923 Motor Cycle Show. They also had the satisfaction of seeing their sidecars on the Brough Superior, Coventry Eagle, Dot, and Matador stands also. George Brough listed the Coupe-de-Lux model as the standard sidecar on Broughs from 1924 to 1927.



### 1.5 The Steib Story - Germany

The Steib story began when Josef Steib started a small family business concern in 1914, specializing in enameling and saddling. His expertise as a coach-builder soon spread. World War I came with its setbacks and difficulties. Not until 1928 did Steib produce his first sidecar.

In 1932, Josef Steib Jr. became the Chief Officer of the company. Under young Josef's dynamic leadership the company progressed and expanded. The Steib business grew into a factory with mass production facilities and assembly lines. Steib's name was legend for quality at home and abroad. So exacting was Steib's production that BMW commissioned Steib to build sidecars for them using the BMW emblem. (Remember when the BMW hauled sidecars?)

Steib made sidecars for BMWs and Zundapps during World War I. The heavy outfit was quite successful on the Western Front and in the Sahara Desert. The driven sidecar wheel made the outfit virtually unstoppable. Steib made thousands of units. The Allies destroyed the Nurnberg factory during a bombing raid. Down, but not out, work continued in the bombed out factory in 1945. They made a civilian version of the famous Army model (no gun mount). This was the Grune Elephant TR500 model.

By 1949 the factory was turning out 12,000 to 15,000 units per year and exporting them to 36

## SIDECAR OPERATOR MANUAL

countries. That was the year the Deutsch Mark replaced the Reich Mark.

Steib produced slight variations on six major sidecar themes. The earliest was the S500/501, the familiar bullet shaped design so loved by sidecar manufacturers of the era. Tension springs supported the body on the early models. The most significant design advance was the leading axle torsion wheel suspension used in later models.

The various Steib models were the LS200, S250, S500, S501, S350, TR500, TR502, RSI, RS2, LT200 and the RSTI. The RS series were for scooters while the last two were tradesmen's boxes. The bodies were of fine quality steel with high quality protective finishes applied. Steib used highly finished aluminum hardware. The fittings were robust, simple, and straight. Their sidecars fitted most motorcycles.

While the economic recovery made Germany prosper in the fifties, it cast the death knell for the Steib family business. The now affluent populace demanded the people's car. Agricultural machinery construction replaced sidecar assembly in the Steib shop. The factory ceased building sidecars in 1960 but Steib is not forgotten. Collectors search eagerly for Steib sidecars. Spares are available while replicas of many models are in Japan, Germany, India and the United States. That is high praise, indeed.

## SECTION 1: INTRODUCTION



Steib TR500 w/ BMW, courtesy SIDECAR, Japan



Steib S500 w/ HRD, courtesy SIDECAR, Japan

## 1.6 Sidecars in Japan

The first motorcycle imported into Japan was an English Thomas in 1904. The first major importer of motorcycles was Fatabaya of Akasuka, Tokyo, who brought Indians from America. Later, Yamaguchi Inc., imported the English Triumph in 1910, and Yamada-Riseikan of Kanda, Tokyo, imported the NSU from Germany in 1912. Importation of Indians increased. In 1916, the Japanese Postal Service imported the Yale, a 950 cc V-Twin from Consolidated Manufacturing, Toledo, Ohio. Toyko had just 37 motorcycles registered in 1916.

The Japanese army used many sidecar combinations in 1918, while the Japanese Police used the Big Red Indian in 1919. Most motorcycles used in Japan in the Twenties were for official purposes although some 3-wheelers did find their way into civilian service.

Narazo Shimazo made the first Japanese sidecar in 1925, the Yero-First. He also made the first domestic motorcycle, the Yero-First motorcycle. It had a 4 stroke side valve engine with a 3-speed transmission and reverse gear. He made a V-Twin in 1935 in premises now owned by Mazda.

Sankyo built a Japanese version of the Harley-Davidson, the Rikuo, under a license from the Milwaukee Factory, in 1931. The 1936 models included a rear transmission to drive the sidecar wheel and the rear wheel.

## SECTION 1: INTRODUCTION

Military vehicles supplied to the Japanese Army in World War II included the Mazda, Kuroyane and the Rikuo. The military police sidecar drivers are called Kenpei, while sidecar mounted police of the Imperial Families are the Konoe-Hei. Some civilians, usually doctors, drove sidecar outfits. They used conventional sidecars fitted to Ariel's (imported by Yamada-Rinseikan) or to Moto-Guzzi's (imported by Mikuni-Shoten). Mikuni now makes carburetors.

The military version of the Rikuo continued in production after World War II, but for civilian purposes. The 252 Rikuos were 90 percent of the total Japanese motorcycle production in 1946. Japan now makes 13 to 16 million motorcycles each year.

Sabaru produced a 169 cc sv Rabbit scooter with a DS-I sidecar, and Mitsubishi produced a 148 cc sv Silver-Pigeon scooter, also with a sidecar. Rikuo continued to produce a Japanese 200 cc sv V-Twin VFD with a 1930's Harley-Davidson style sidecar.

Kawasaki (formerly Meguro) produced a 500 cc single OHV with a Harley-Davidson type sidecar. Cabiton produced a replica of the Ariel and a replica of the German Steib LS200. Their unit used a 500 cc OHV twin power plant.

Surplus aircraft fuel tanks were popular as sidecar bodies because of the shortage of raw materials in the post war era. Journalists and Police Departments favored sidecar units.



Tairiku Standard - Japan - Kaz Ozeiki



Jewell - France >> Japan - Kaz Ozeiki



Neval-Dniepr - UK and Russia >> Japan - Kaz O.



DJP - Australia >> Japan - Kaz Ozeiki

## SIDECAR OPERATOR MANUAL

The Minato sidecar, produced by Fuji-Kogyo, fitted motorcycles and scooters. The Yasui sidecar, by Yasui-Kogyo fitted the Rabbit Scooter. The Izumi sidecar, by Izumi-Kogyo fitted the L.E. Velocette and other machines.

The Minato sidecars, originally made for Meguro and Honda, were later exclusive to Yamaha. Minato, through their Fuji-Kogyo outlet, made sidecars for other brands. Sidecar production ceased in 1966 because of the introduction of Minicars such as the Daihatsu 3-wheeler 200 cc 2 stroke.

The last sidecar of the post war era was the Sanshin boat of fiber glass construction (all prior sidecars were of steel). Sanshin is now part of the Yamaha complex. The detachable Sanshin body also served as a boat with an outboard motor fitted. The Japanese had lost interest in sidecars by this time.

Sidecar revival came to Japan in 1968. One of the sidecars exhibited in the 1968 Japanese Motor Show was a racing type sidecar fitted to a Kawasaki Mk III. Another was a conventional sidecar fitted to a Kawasaki WISA 650 cc OHV Twin. These sidecars, built by M. Ohta of Tairiku Motors, were on the Kawasaki stand. The WISA, or WISS in America, was a copy of the British BSA Twin. Meguro designed it for Kawasaki.

Kawasaki obtain their sidecars from Tairiku Motors, the only sidecar manufacturer. Tairiku also made sidecars for private sale to enthusiasts. The

## SECTION 1: INTRODUCTION

President, Mr. Masayoshi Ohta, was the importer for BSA and BMW. He also sold rebuilt Steib TR500's. He developed a streamlined fiber glass body to fit BMW's and Moto Guzzi's. Sidecars cost about the same as a motorcycle because of their hand construction.

The Japanese Land Transportation Office denied Kawasaki permission to sell and register 200 motorcycle combinations because of the unique driving technique for a sidecar combination. They felt it strange to have one technique to turn to the right, and another to turn to the left. They finally allowed that 30 were okay but 200 were dangerous! This absurd notion remains with the Land Transportation Office.

Another oddity is that while Japanese sidecars are "unsafe", foreign sidecars are "safe". Watsonian and Harley-Davidson exported sidecars to Japan in 1970, followed by the Bingham in 1973, and the Bender and Velorex in 1974. The Ural and Dnieper came in 1976, the Squire in 1978, and the American Spirit in 1979. The Chonjian and the Don-hai came from China in 1980 and 1981, respectively. Some imported exclusive models such as the EML and HMO privately. Only dedicated sidecar enthusiasts own and drive sidecars in Japan today.



## 1.7 Australian Sidecars

Australia with its expansive remote interior, has always challenged road transportation. The early automobiles in Australia were for the upper class while motorcycles provided the basic transportation for the masses. Sidecars have always been part of the Australian motorcycle scene but their numbers have dwindled so they are now a rarity.

Only the biggest and stoutest motorcycles could survive the enormous distances and bad roads. The large American motorcycles survived the early Australian roads while the smaller British and European machines did not. The Pope, and the Thor were popular before World War I. Other popular machines were the Indians, the Harley-Davidsons, the Excelsiors, and the Hendersons.

A few European bikes made an appearance in the Thirties (BMW, Zundapp, and DKW). The British and the Americans competed heavily for a marketplace in Australia after World War II. The Japanese killed their efforts and now reign supreme.

There were some attempts to produce Australian motorcycles but almost all motorcycles ever used in Australia are of foreign origin. Such however, is not the case for the sidecar. Most sidecars in Australia are of Australian manufacture. The sidecar is of domestic origin because of simple economics. It is a low-tech item.

The hand-made sidecars designed for Australian conditions were big, heavy, and simple. The early

manufacturers did not copy their counterparts from overseas but designed them for local conditions. There was the Floater and the Floatette, the Chassis-less Underwood, and the Goulding. Goulding later moved to the United States. He continued to make large sidecars for Indians and Harley-Davidsons with the skills developed in Australia.

The most popular make was the Dusting. The Murphy came from Sydney, the ever popular Tilbrook from Adelaide and the Yeats' from Melbourne. Goulding used an attachment under the saddle. The lower front connection was often halfway up the front frame tube.

The Dusting, Murphy, Yeats, and Goulding were the sidecars before World War II. Dusting and Murphy used rubber bushed attachment fittings. Yeats used this setup but carried it further. They extended the saddle brace fitting across and under the sidecar.

A "C" type spring attached the fitting to the sidecar frame near the sidecar wheel. The rubber bushed fittings provided flexibility with the Yeats' sidecars having the most. The rubber bushed fittings were a necessity. The early Australian highways, strongly corrugated gravel roads, often had large pot holes or rocks protruding through the road surface. The frames had to be hellish stout or flexible to absorb this pounding. The rubber bushings reduced the cyclic stress loading



Premier on 1995 Triumph Spirit  
Photo supplied by Andy Weeks, Aust.



White HRD on BMW K1100  
Photo supplied by Chris McArdie, Aust



Wescar steel sidecar on a modified BMW R65  
Photo supplied by Andy Weeks, Aust.



Higgins (Oz) on K1100 set up for desert cross  
Photo supplied by Chris McArdie, Aust

## SIDECAR OPERATOR MANUAL

but did not permit the outfit to slop about. Without these flexible couplings the frame of the motorcycle, or the sidecar frame, or the mounting points would break.

The old-time sidecar builders believed in springing the sidecar body separately from the sidecar chassis. A typical pre-war outfit had a rigid rear end and a rigid sidecar wheel while the body floated on long semi-elliptical springs. Others used coil springs or some combination of springs. This contrasts to modern rig design. The unit is sprung at the rear and the sidecar wheel while the body is rigidly or rubber mounted.

The Tilbrook sidecar made its debut after World War II. Rex Tilbrook had the praise-worthy ambition to recreate a local motorcycle industry and did manufacture Tilbrook motorcycles in limited quantities. His reasoning was sound. He would enter the motorcycle market by way of the traditional Australian motorcycle accessory, the sidecar.

While Goulding and Tilbrook produced racing sidecars, privaters build most speedway racing machines. A new breed of speedway racer, built near Sydney, uses a design based on European sidecar motocross machines. The earlier racing hacks are still competitive.

Sidecar production, quite heavy before/after World War I, revived briefly after World War II when cars were scarce. Sidecar production peaked in the mid Fifties and sales in the mid Sixties were stagnant.

## SECTION 1: INTRODUCTION

A mini-revival in the late Sixties produced a small but steady supply of sidecars which continued. Recent manufacturers include DJP, Bolt-on, R&B Sidecars, and Australasian Sidecar Specialties. These disappeared while others such as Premier, Sidecar Engineering, HRD, West Car, QSB, and Sun Coast took their place.

Sadly, with the advent of the 21st century, many of the stalwarts of the industry have found other ventures or just retired, including HRD (Ron Hurdis),.

Today's lineup still includes Premier (Ian Souter), joined by Oz Sidecars (Geoff Higgins), both continue to make their own bodies. Ern Jeffrey (Dusting), AFAIK, owns the rights in Oz, and makes mounts and chassis. Premier sells the Dusting body. Bob Martin Engineering of Fern Tree Gully, Melbourne, Vic. is the place to go for the sidecar chassis, LL forks, etc

Grateful note: photos and latest info supplied by Andy Weeks and Chris McArdie. Graham Posker seems to know where all the sidecars are buried. Thanks.

## 1.8 Why a Sidecar

Sidecaring is not for everyone. How can you tell if it is for you unless you know how an outfit handles? This manual tells you how and why it is so different. As you read on you can determine whether its particular handling behavior is, or is not for you.

If most of the advantages appeal then you may seriously consider trying to at least beg, borrow or steal a ride. As we want you to think positively, here is a list of pluses.

Anyone can drive a sidecar outfit. You do not put your foot or feet on the ground for balance when at rest. Your petite girlfriend can handle a rig in much the same fashion as her big hulking brother. With special controls, paraplegics have enjoyed cycling on three wheels. Some units accommodate a wheel chair and crutches.

All is not fun and games. For the advantages outlined you will have to make some sacrifices. The first is the pocketbook. A sidecar can cost as little as \$900 (used) or more than \$9000 for a fully furnished sidecar. Your total investment for machine and sidecar can run from \$1500 to \$30000 or even more. You sometimes get what you pay for.

You can no longer drag out at the traffic lights. You can no longer brag about how you scraped off a piece of knee leather while laying it over at Devil's Corner.

If you wish the advantages outlined and can live with the disadvantages, then sidecaring is for you.

### 1.8.1 Advantages

Your stability increases. Unless you do something silly you will neither bring the chair over yourself nor throw the rear wheel over the chair. You can do either if you try.

With skill, no reasonable ground surface will stop you. You will never drop an outfit down on ice, snow, gravel or mud although you may slide a little or a lot. No longer is hitting a greasy manhole cover, a pot hole or a curb, a tankslapping experience. Any of the three tires can blow without instant loss of control.

Car drivers can more easily see you and respect your right to the road. You have much higher defense. When a car hits the soloist head-on, the impact causes the rear of the cycle to lift. This catapults the hapless rider and passenger into the windscreen of the car. He may fly over the car into oncoming traffic behind the car.

With an outfit, most of the added weight is behind the center of mass of the cycle. When a car hits the outfit, also head-on, the added weight of the sidecar keeps the rear down. The front wheel, fork and the nose of the sidecar collapse and absorb the impact. You and your passenger will usually walk away. This happened to me when I was 20 years old in Perth, Western Australia.

## SIDECAR OPERATOR MANUAL

Your outfit is not a tank. When big things and little things come in contact, the big things will not suffer while the little things get smashed. Another law from Newton. Sidecarists can and do get killed. However, a car driver cannot just scare you off the road by driving close alongside you. You can brake and get behind him. If he wants you, he must deliberately hit you. The car driver, the nemesis of the soloist, gives the sidecarist more respect and courtesy. You will enjoy your new-found experience.

Your solo machine is almost useless to do the week-end shopping. You cannot pack enough ice and beer to enjoy a week-end of fishing with the boys. Nor can you haul Mama, the kids, the picnic basket and the spread. You cannot carry ample supplies and tools for your trip from to Alaska to Tierra del Fuego. Your outfit can.

Your and your passenger can enjoy the comfort of a car - well, almost. Some sidecars come with a hood or hardtop, radio, telecom, mirror, upholstery, fan, and heater. Only your ingenuity governs your limitations. You remain in the open.

You climb off your machine on any type of ground surface. You smile smugly as the mounts of your solo companion's machines break through and sink gradually in hot asphalt. You will never come back and find your machine lying on its side. Your outfit is at ease in the wet, or on ice or snow. With all weather clothing you do not need a summer motorcycle and a winter car.

## SECTION 1: INTRODUCTION

### 1.8.2 Disadvantages

A sidecar reduces the performance expected of your solo. It will have an increased thirst for gasoline, tires, chains, sprockets, and spokes.

Allow for the width of the outfit to prevent pedestrians on sidewalk corners and your sidecar passenger from meeting. You will wait in traffic with other commuters.

Your outfit requires more garage storage space. Something else in the garage may need to go (your wife's car, for example).

Accessibility to some cycle parts could be reduced, especially on the right side. The sidecar frame may interfere with removal of alternator covers or other engine components.

The ride is harsher because of the stiffer suspension needed. Hitting a bump with any of the three wheels will jar both rider and passenger. You may hit more bumps as it is easier to hit the bump than to wrench your way around them. On a solo you simply glide by with little effort. Some outfits have a tendency for front wheel wobble at slow speeds.

You must have patience to learn an entirely new set of riding habits. You must forget your solo experience, except the basic motorcycle controls.

It is easier for a non-motorcyclist to learn to pilot a sidecar rig than it is for the average long term soloist. The amateur has nothing to forget.

## 1.9 Modern Sidecar Technology

While motorcycles have advanced very rapidly the last few decades, motorcycle sidecar design technology has fallen behind. It is not uncommon to see sidecars of the 1960's (or earlier) coupled to sophisticated 2000's models motorcycles.

An example of modern technology applied to sidecar design is the electrically adjustable motorcycle lean control by Vern Goodwin. This enables correct lean adjustment for sidecar loading, or for combatting cross winds or road crown. When used while in motion it makes steering easier.

The finest example of sidecar technology is the turbo-diesel, three-wheel drive, two-wheel steering Corda from Sweden. Look for a price tag of 300,000 Swedish Crowns or over \$ 40,000. Only a fortunate few will ever drive one. The fully enclosed sidecar seats two people in comfort.

The rig handles like a well mannered sports car. It can turn to the right as quickly and as easily as it can turn to the left. This is very unusual for any sidecar rig. The unitized frame provides support for the motorcycle. It features a 71 hp VW engine and automatic transmission, motorcycle wheels, sidecar wheel, and a sidecar body. Its massive fuel tank provides a 1200 km touring range. Top speed is greater than 105 mph.

Sidecar performance requires certain physical changes to the motorcycle. The sidecar is not an

## SECTION 1: INTRODUCTION

appendage like a set of saddlebags. The motorcycle, its size and power, is taken into account when considering a sidecar. They exist, as interdependent units, one to the other. No Japanese showroom motorcycle is suitable for sidecar use without certain changes.

There is an unresolvable problem people have with "that damn sidecar." It is unresolvable as it often does not exist.

It is not just the sidecar, but features of the sidecar on the motorcycle. A sidecar manufacturer's job is not over when he finishes a sidecar. The way an outfit handles depends on how the sidecar is mounted and the motorcycle preparations made to accept the sidecar.

There are three categories to examine in any sidecar. First, the sidecar. A manufacturer must consider the final use his customer will have, in addition to particular features of the sidecar itself. The design must compliment the motorcycle, not detract from it. The sidecar is useless by itself.

Next, the sidecar must mount to the motorcycle to create a dual track vehicle from a single track vehicle. The structure is only as good as the foundation. A strong mounting system is essential.

The mounts must attach to the main frame and spread the loads uniformly. They must not slide, rotate, or shift. They must not bend or crush the frame.

## SIDECAR OPERATOR MANUAL

Finally, there is the motorcycle. The motorcycle manufacturer designed his machine for certain load conditions. He did not intend you to attach a sidecar. The sidecar causes stresses in places he had not strengthened. New lateral loads appear. The wheels and tires must withstand the new lateral forces. This requires higher strength motorcycle wheels. The wheel may be re-laced with stronger spokes or replaced with mag wheels.

The sidecar imposes added weight on the motorcycle. The motorcycle suspension will require stiffening for good results.

A rigid sidecar needs a different steering geometry. All changes of direction are by steering instead of leaning the motorcycle.

The large trail, best for solo use, creates high turning forces in a sidecar outfit. A reduction in trail is highly desirable for easy handling of a sidecar unit.

A few motorcycle manufacturers supplied motorcycles with a means to change trail geometry when using a sidecar. Examples are BMW's and Harley-Davidson's of earlier days, and the fabulous HRD Vincents.

Present day motorcycles, unless specially made by European sidecar manufacturers such as EML or HMO, do not offer this convenience. The leading link front end is the answer.

## SECTION 1: INTRODUCTION

Do not neglect any of the mentioned categories. The end product is only as good as its mounting setup, its alignment, and its attachment to a correctly prepared motorcycle.

Driving a sidecar rig is entirely different from driving a solo motorcycle. The sidecar influences the total handling of a motorcycle. The sidecar will lag when accelerating. It will also try to remain in motion when braking.

A sidecar wheel brake can compensate for the sidecar weight when applying the brakes on the motorcycle. This reduces braking distance, and the urge of the rig to go left during braking is lessened.

Excitement can be attained at lower speeds and with safer conditions on a sidecar unit than with a solo motorcycle. You should evaluate a sidecar by having a long ride in one, and by observing one in motion.

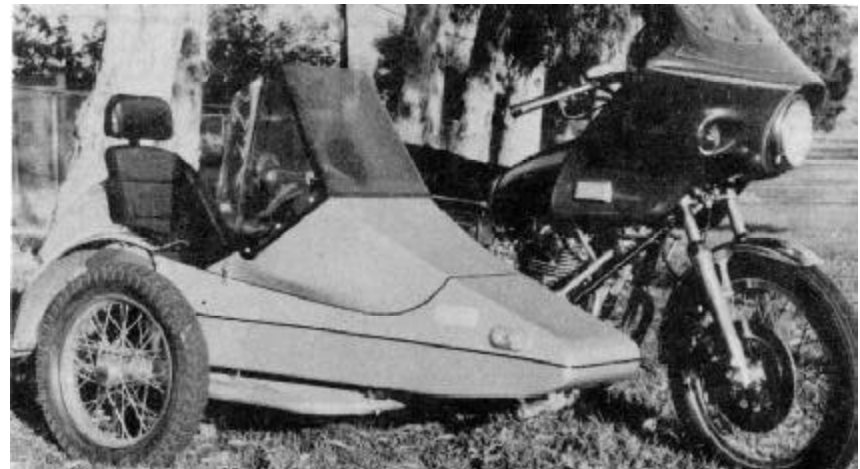

Thompson CycleCar

## SIDECAR

### 2. SETTING UP AN OUTFIT

A properly set up outfit is a joy to behold and a pleasure to drive. Conversely, an improperly set up outfit handles like a beast, is dangerous, and sheds tires rapidly. This section covers the mechanics of setting up an outfit properly.

#### 2.1 Matching a Sidecar to a Motorcycle

Having decided you really want a sidecar, how do you match the sidecar with the cycle? Almost any motorcycle can and will pull a sidecar, more or less successfully. Sidecars attach to all types of motorcycles from the smallest Vespa scooter to the largest 1500 Honda Gold Wing.

You must decide how large a unit you require and what performance you expect. Do not expect the 305 Honda Hawk to pull a 300 pound Motovation Coupe Royale. A California Sidekick does not fit a Suzuki Cavalcade. The sidecar should weigh between 25 to 35 percent of the weight of the cycle. If the sidecar is too light (for the cycle) it will be very difficult on right-handers, especially when empty. If the sidecar is too heavy it will drag or pull hard to the right when accelerating. It will also push hard to the left when braking. In either case, the rig will not "feel" right.

A wide choice of power units exists for any given weight range. If you like the performance of a particular motorcycle you will need from 25 to 35

### 2. SETTING UP AN OUTFIT

percent more power to get similar performance (acceleration and top speed) from an outfit. You may expect a similar performance from a 800 cc engine pulling an outfit as you obtained from a 550 cc engine installed in a solo.

Another rule of thumb is:

<b>ENGINE SIZE</b>	<b>CRUISING SPEED - MPH</b>	
<b>CC</b>	<b><u>SOLO</u></b>	<b><u>SIDECAR</u></b>
350	65	55
500	85	65
750	105	75
1000	130	85
1500	125	95

The smaller the engine, the greater the strain you place on it. The engine must work harder at the same speed. The engine runs hotter as there is no greater cooling. The oil breaks down sooner. The engine wears out faster.

You also make down shifts more often. You spend more time in lower gears. It is harder to climb steep hills. So is battling stiff head winds. A 500 cc outfit may be satisfactory for city driving but a 750 cc or larger is better for touring. While top performance requires a power plant of 900 cc or more.



## SIDECAR

A slow speed engine with a broad high torque curve is better than a high speed engine with a peaked power curve. The HRD Vincent Rapide, an excellent chair puller, used a Vee-Twin which developed maximum power at 5600 rpm. The larger BMW's were highly desirable as sidecar machines. Now in the US they take second place to the Honda Gold Wing. Will the 1500 cc Wing be the sidecar machine of the future? They have engines with strong power at low engine speed.

With a sidecar, you just cannot cut between lanes. In slow moving traffic, your slowest permissible speed may be too fast to stay in the traffic flow. A Laverda i000, even geared down, has a minimum low gear speed of 15 mph. What do you do if the traffic flow is 10 mph or less? If you anticipate this traffic situation a lot, perhaps a Moto-Guzzi V-1000 convertible is for you. An automatic is the only way to cope with crowded down-town rush-hour situations.

Your motorcycle and sidecar represents a sizeable cash outlay. Consider your needs carefully. Unlike the family sedan, it is difficult to trade bikes and sidecars at will. Like a marriage partner, once selected it will be with you a long time. Sidecarists do not trade their outfits often.

## 2. SETTING UP AN OUTFIT

### 2.2 Tips for Mounting

- Work on a smooth, flat, hard floor surface.
- Tie, brace, or support the cycle in a true vertical position so it can't shift position. Don't put it on the center stand.
- Place the sidecar in the proper position with relation to the cycle (per instructions). Block it up firmly so it can't shift position.
- Study the instructions for mounting from start to finish so you understand them thoroughly.
- Follow each step of the instructions exactly and carefully. Don't hurry. If in doubt, stop and think it through.
- Don't tighten the connections fully until all connections and struts are in place.
- Take frequent measurements of the sidecar wheel toe-in. Also check vertical lean of the cycle, and the horizontal position of the sidecar and sidecar frame.
- On final tightening of all clamps and fasteners, get them tight! They must not slip or move. Refer to the manufacturer's instructions on tightening the clamps. Do not crush the thin cycle frame member.

## SIDECAR

### 2.3 Alignment

#### 2.3.1 Sidecar Wheel Lead

Sidecar wheel lead is less critical than other alignment adjustments. Once chosen, the sidecar wheel lead determines where the sidecar and frame will be, relative to the motorcycle. Other alignment adjustments are fairly easy.

The lead, or distance rearward from the sidecar wheel to the rear wheel, varies from zero to 15 inches. Early H-D's with a rigid frame used no lead. Racing hacks used for one way oval tracks have very large leads. Most modern rigs use between 8 to 12 inches of lead.

Consider an outfit with Zero lead. This is equivalent to a four wheel car with the right front wheel missing, and only the left rear wheel providing traction. Few scrubbing forces arise when turning

left or right. However, weight distribution is extremely poor. The added weight on the front wheel makes steering heavy while the rear wheel can leave the ground on a hard left-hander. The outfit can roll over along a pivot line between the sidecar wheel and the front wheel in extreme circumstances.

The sidecar wheel takes more load as lead increases while weight on the front wheel reduces. The sidecar wheel positioned midway between the front and rear wheel gives ideal weight distribution.

#### 2. SETTING UP AN OUTFIT

This is ideal for straight ahead driving. The more the sidecar wheel moves forward, the more it creates scrubbing on turns, especially to the left. The sidecar wheel can pivot, or even rotate rearward if located too far forward, or if the front steering lock stops allow very sharp turns. Locate the sidecar wheel towards the rear for normal driving conditions.

Another concern is the type of rear wheel suspension. When only rigid frame machines existed, the lead was small, normally from zero to 3 inches. With the advent of sprung hubs and rear plungers, the lead advanced to 4 to 6 inches. The development of modern swinging arm suspension resulted in larger leads of 8 to 12 inches. The farther forward, the better weight distribution. The farther rearward, the easier the turn and less scrubbing of tires on turns.

Some early experimenters pivoted or castored the sidecar wheel to reduce turning scrubbing forces. It did not work very well. With the exception of the 3-wheel drive, 2-wheel steering system of Corda, most modern inventors have not found a good solution either. The Corda claims to drive as fast to the right as to the left, and at speeds to rival a modern sports car.

LEAN OUT ILLUSTRATION

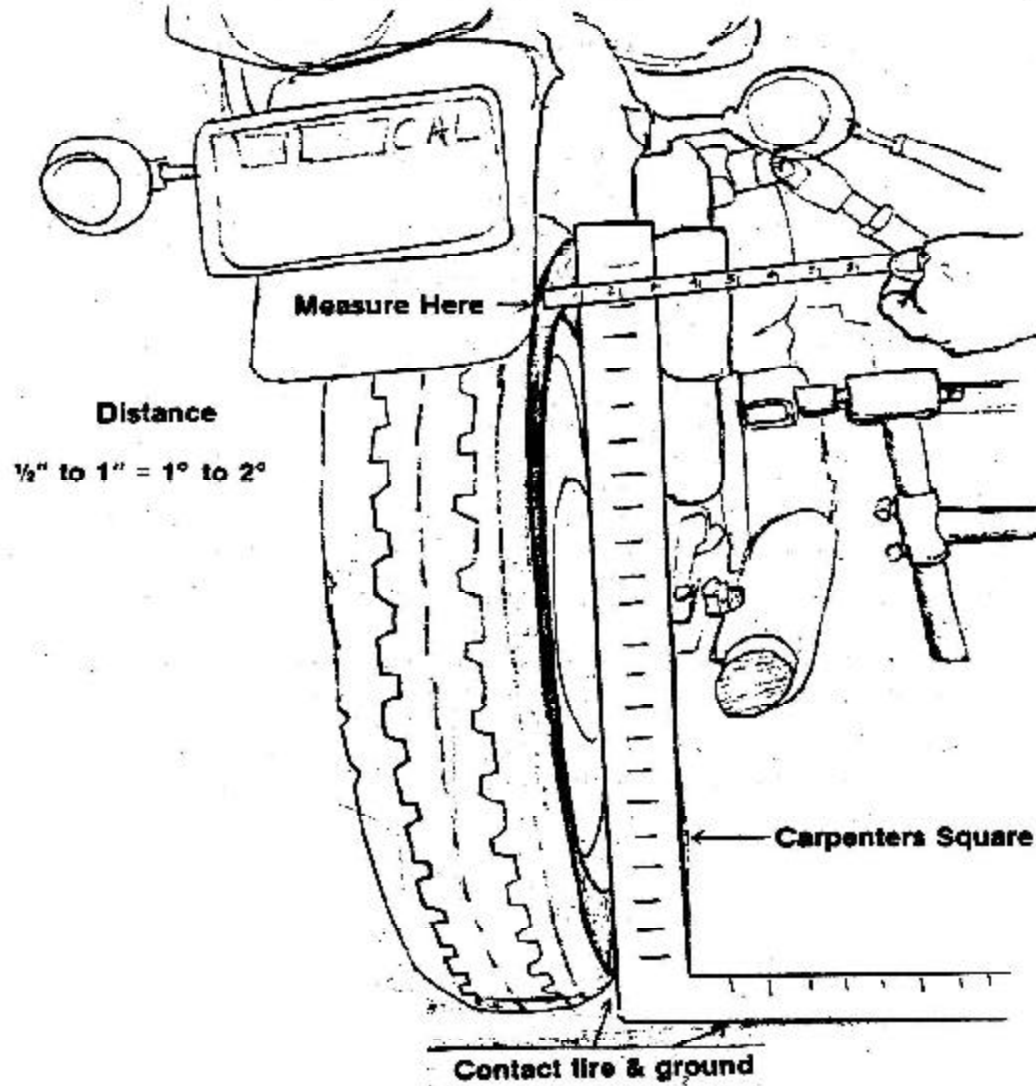

Copyright © 1978 by Thomas L. Pedersen All Rights Reserved

## SIDECAR

### 2.3.2 Leveling the Frame

With the sidecar wheel lead established, the next item to set is the attitude of the frame. The frame, when viewed from front or rear, should be horizontal with the motorcycle and the sidecar normally loaded. When viewed from the side, a very slight forward tilt upward gives a pleasing appearance. The angle, if any, should not be noticeable.

Some models allow adjustment of frame height. The lower the frame the greater the stability and road-holding but with less ground clearance for trials events. A good street racing hack would get high centered on a moto-cross track.

### 2.3.3 Toe-in Adjustment

Sidecar wheel toe-in provides the sidecar wheel with a slight bias toward the motorcycle. This partly counteracts the drag of the sidecar. One unbalanced drag force comes from wind resistance of the sidecar body and tire. Another is the road friction of the sidecar tire and the drag caused by the toe-in itself.

Use correct tire pressure to reduce drag. Keep the bearings properly lubricated, and use a low profile streamlined sidecarbody. Less drag requires less toe-in. Too much toe-in results in rapid tire wear. Not enough toe-in causes the outfit to pull towards the sidecar. A correct balance allows the outfit to maintain a straight line without pulling.

## 2. SETTING UP AN OUTFIT

It should not pull while cruising a level surface at 30 mph with the outfit normally loaded.

### Check Toe-in as follows-

With the outfit on a hard level area (garage, for example), place one 2" x 4" parallel to the outfit on the outside of the motorcycle (opposite the sidecar). Make sure the rear wheel is parallel to the motorcycle frame and the frame is not distorted or bent.

Gently nudge the 2" x 4" so it rests against the rear wheel. With the front wheel pointed straight ahead, bring the 2" x 4" parallel to the front wheel. Make an allowance if the rear tire is wider than the front. Do this by fitting two shims equal to one-half the difference in width between the maximum cross section of the front tire and the rear. Nail shims onto the 2" x 4" where it will contact the front tire. Measurements will be more accurate if the 2" x 4" rests upon a brick at the front end and at the rear.

Take another 2" x 4" and gently lay it against the sidecar wheel at the same height as the first 2" x 4". Make sure this 2" x 4" is parallel to the sidecar wheel. You are ready to check toe-in.

Measure the distance between the outer edges of the two 2" x 4" 's slightly ahead of the front wheel. Repeat the measurement just behind the rear wheel. The second measurement should be between 1/2 to 1" larger than the first measurement for normal adjustment.

## SIDECAR

Correct toe-in is the minimum that allows straight ahead steering. Set it with the cycle lean-out described below.

### 2.3.4 Lean-out Adjustment

Experts dispute the lean-out required. Some say the motorcycle should lean in, some say it should lean out. Others say the motorcycle should be vertical. It is unique for the specific motorcycle, sidecar and rider. If the motorcycle leans notably in or out it is not set up correctly.

The more the motorcycle leans out the easier to make left handers but the easier to pick the chair up on the right handers.

The more the motorcycle leans in the harder to pick the chair up on right handers but with more effort in making left handers.

The motorcycle, when the outfit is normally loaded, should have between one and two degrees of lean-out. A plumb bob dropped from the rear of the saddle to the ground must not be more than about 1/2 inch from the center-line of the rear wheel contact patch. Heavier units require greater lean-out (H-D, for example, suggests two degrees of lean out for better handling).

Toe-in and lean-out go hand in hand. Both should be minimum yet still provide best overall handling.

## 2. SETTING UP AN OUTFIT

### 2.3.5 Wheel Track Width

Track width of most outfits is about 50 inches, +/- 3 inches. The track width is the distance from the center-line of the sidecar wheel to the center-line between the front and rear wheels of the motorcycle.

A greater track width means greater stability on right handers at the expense of harder left steering. A smaller track width means easier steering with less stability on right handers and less sidecar drag.

Newer double width sidecars have track widths up to 60 inches or more. European outfits have narrower track widths more suitable for high speed cruising.

### 2.3.6 Reducing the Muscle Work

Vic Willoughby of Motor Cycle, Ron Watson of Watsonian Sidecars and Eric Oliver, World Sidecar Champion (four times over) conducted several sidecar tests. These tests showed how alignment changes, load variations, and fork trail settings alter sidecar handling. They used a Royal Enfield 692 cc Super Meteor harnessed to a Watsonian Maxstoke child/ adult sidecar fitted on a VG21 chassis with sprung wheel. The sidecar outfit is a normal left hand chair. Read more on the tests in Motor Cycle, February 27, 1978.

The first test used the machine as it had been setup and driven normally.

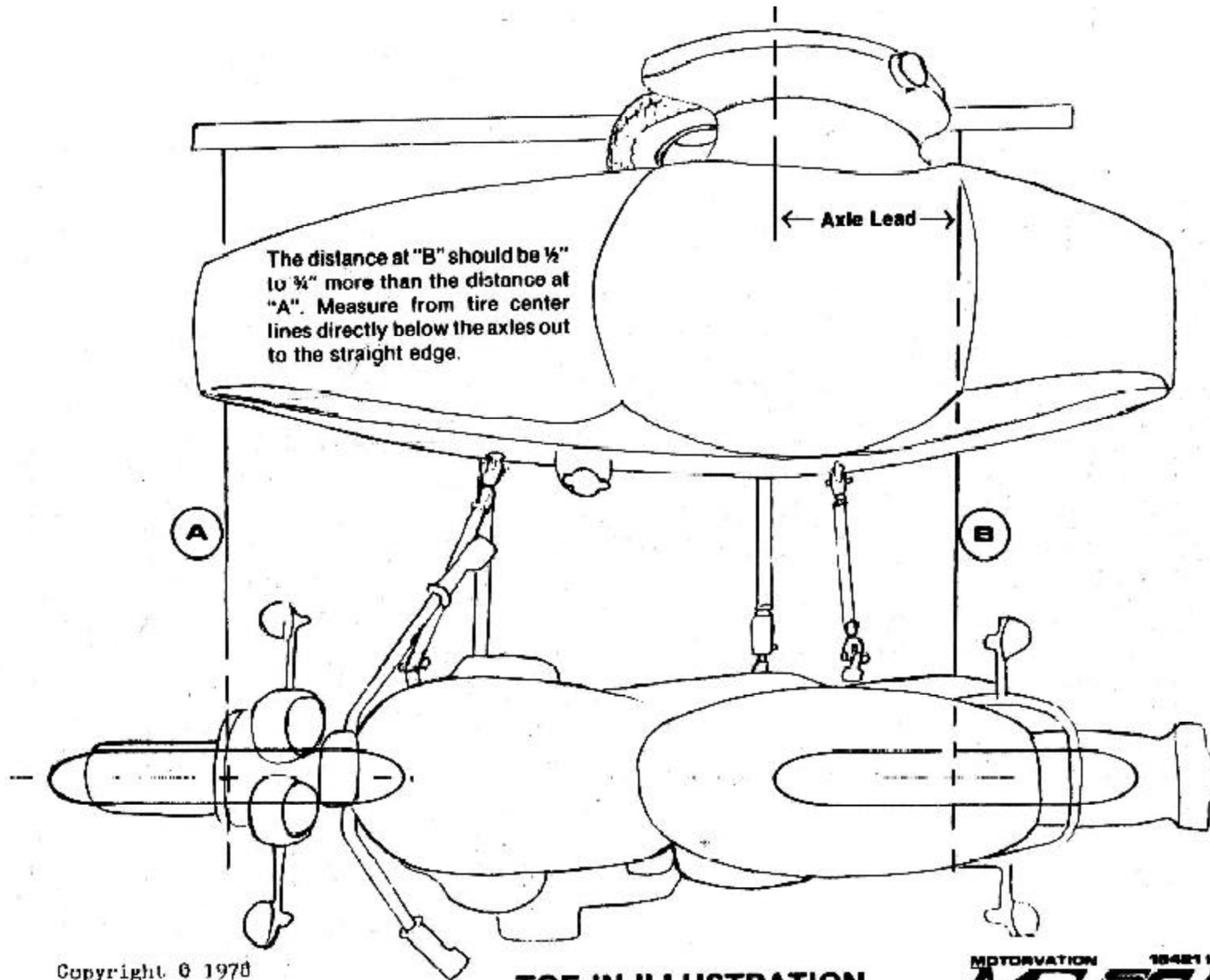

The distance at "B" should be 1/2" to 3/4" more than the distance at "A". Measure from tire center lines directly below the axles out to the straight edge.

← Axle Lead →

A

B

Copyright © 1978  
by Thomas L. Pedersen  
All Rights Reserved

**TOE IN ILLUSTRATION**

MOTORVATION 18421 HART STREET  
**M INC ECARS**  
ENGINEERING REBECA, CA. 91335

## SIDECAR

Settings were- trail -- 1.75"; toe-in -- " ; lean-out - - 0.5" ; and lead -- 4 inches. All measurements taken with the machine normally loaded.

Tire pressures were- 30 psi rear, 3.50; 22 psi front, 3.25; and 24 psi sidecar, 3.25.

Steering was very light with the sidecar empty. It took little effort to lift the sidecar up or slew the outfit around in tight turns. The front wheel would crab easily on right handers.

Alignment, as shown by a hands-off test, was spot on when loaded with a passenger in the sidecar.

The first change was to alter the motorcycle lean. The passenger left the sidecar and mounted the pillion seat. This compressed the front and rear springs farther and increased lean-out. The outfit now wanted to pull in the direction away from the sidecar.

With the additional lean-out removed, the outfit wanted to pull in the direction toward the sidecar.

The second test was to show the result of changing toe-in. They changed the toe-in to 5 inches. The effect on straight ahead steering was very slight. When adjusted to give 6 inches of toe-out there was a distinct pull toward the sidecar. Expect abnormal tire wear in either case. This was not proven in these limited tests. (I can vouch for abnormal tire wear. Shredded a new rear tire in only 700 miles after a shop "aligned" my 1972

## 2. SETTING UP AN OUTFIT

Triumph with a Stieb sidecar. Gross misalignment is often accompanied by severe continuous side pull. Correcting this sidepull will cause stinging shoulder strain and pain. - HAK.)

The third test involved changing weight distribution. Initially, the passenger sat in the front sidecar seat with the rear seat empty. When the outfit was slewed around the rear wheel came off the ground by about a foot. A previous test with the sidecar empty caused the outfit to slew but the rear wheel did not lose ground contact. With the passenger in the rear seat, the outfit could not be slewed around and it was difficult to lift the rear wheel.

Reckless turns away from the chair, and with a forward load, can cause the cycle to flip over the sidecar. Always carry loads in the sidecar as far rearward as possible. It did not make any difference where the passenger sat in the sidecar when turning towards the chair. The chair lifted up with the same ease. The more weight, the more difficult to pick up the chair.

If you carry only one passenger on a sidecar rig, place the passenger in the sidecar as far back as possible. The worst place for one passenger is on the pillion behind the driver. Lean-out increases while the center of gravity shifts toward the cycle.

The fourth test changed the lead of the sidecar wheel. A lead of about 3 inches is effective with a rigid rear wheel suspension. The rear of the cycle is very easy to pick up on turns away from the

## SIDECAR

sidecar if there is no lead at all. A fully sprung outfit rolls more with a small lead. A lead of 8 to 12 inches prevents nose dipping when turning away from the chair.

Moving the lead forward did not make much change. It was more difficult to lift the rear wheel. The sidecar was slightly easier to lift but otherwise handling did not change. Excessive lead limits cornering speed away from the sidecar by causing the front wheel to break away and crab.

The final test involved changing the front wheel trail from 1-3/4 inches to 3-1/8 inches by changing the front fork sliders. Straight ahead driving was unaffected but cornering effort increased enormously. This could prove tiresome (but not proven in the limited tests).

In conclusion, the outfit handled best before any changes. They restored the original alignment.

## 2. SETTING UP AN OUTFIT

### 2.3.7 Alignment Problems-

	<u>Pulls to the:</u>		<u>Hard to Turn:</u>		<u>Wobble</u>
	<u>Right</u>	<u>Left</u>	<u>Right</u>	<u>Left</u>	
Increase Toe-in-	X			X	
Reduce Toe-in-		X	X	X	
Increase Lean-out:	X			X	
Reduce Lean-out:		X	X		
Increase Lead:	X				
Reduce Lead:		X	X	X	
Stiffen Shocks-					X
Steering Damper-					X
Balance Front Wheel:					X
Tire Pressure-					X
Swing-arm Bushing-					X
Increase rigidity of S/C mounts, fittings					X

Add ballast to sidecar if it lifts too easily on right handers or reduce leanout. Reducing leanout may cause the rig to pull to the right, corrected by further toein. All adjustments are interdependant. Excessive tire wear results from incorrect alignment, excessive sidecar wheel lead, too much toein, or too little tire pressure.



## SIDECAR

### 2.4 Frame Supports

Sidecars can hang anywhere on a solo frame if you just wish to "look" at an outfit. It is a different matter if you want to actually "drive" the outfit.

Some outfits have one single clamp (Lambretta Scooter fitted with special Watsonian sidecar). Others have two (Vespa Scooter with Vespa Sidecar), or three (H-D with H-D sidecar). Most have four clamps and a few have five clamps (Squire fitted to a Honda). Some early Wessix chairs used seven clamping points.

Many motorcycle frames, at least up through the sixties, included a sidecar attachment. Typical frame brackets were just below the rear of the gas tank and just below the head-stock. Some included ball joints near the rear axle (on rigid frames) and at the lower front of the frame.

Sidecar popularity waned in the sixties and the sidecar attachment points disappeared. The BMW, world renowned for its sidecar powers before 1969, changed the cycle frame construction drastically. BMW no longer recommends fitting sidecars to any BMW built after 1969.

Most motorcycles, except a Harley-Davidson set up for a sidecar, now require some modifications. Newer BMW's require a helper frame which strengthens the basic frame and allows easy attachment of most sidecars.

### 2. SETTING UP AN OUTFIT

Check the frame to determine its lateral strength. Look for a cycle with a heavy duplex frame. Frame attachments must clamp or affix to the frame. Locate them at or near a frame cross member or engine mount. This transmits loads to the other side of the frame. Where possible, tie BOTH sides of the frame together.

Space mounting points as far apart as possible. Place one just below the steering head, another on the front down tube and as low as possible. Put the third below the saddle and as far back as the frame is solid. Locate the fourth below the gearbox on the main frame.

Some sidecars use only three mounts. A central upper mount, and two lower mounts. This is an ideal arrangement for an adjustable leanout - whether mechanical, electrical, or hydraulic.

Some motorcycles use the engine as a stress member. They do not have or need a lower front frame. Depending on the bike and chair, you may or may not need a special sub-frame. The HRD Vincent did not. The lower front mount went through a special reinforced bushing in the massive crankcase for that purpose. I used two upper mounts and a lower mount only on a 750 Laverda. However, I did install a stress spreader angle fitted across the front row of crankcase studs to eliminate sidecar wobbles, not front end wobbles. While no two professional sidecar installers will mount up a specific sidecar to a specific bike exactly the same certain rules apply.

## SIDECAR

Motorvation Engineering uses four clamps:

1. The highest possible point on the right front frame tube, clear of the gas tank and other hardware.
2. At a point about 9" to 17" from the ground (motorcycle level) on the right front frame tube, clear of the exhaust or accessories.
3. Some frame tube member near the swing arm pivot about 9" to 17" from the ground, clear of the exhaust system or accessories.
4. On the frame member, near the top rear shock mount, or seat. The frame diameter at these points determines the correct size of clamps.

Sometimes four points are not accessible for frame mount clamps. Then you need a fixture.

Make all connections very strong. Do not use any hardware if the bolts are 1/4" diameter or less. Cast or forged fittings are normally much better than clamps of thin sheet stock. Use goose-necks of heavy pipe (1/8" pipe wall, at least) and free of any bending creases.

Use heavier fittings are for heavier machines and sidecars. Fittings suitable for a 130 pound sidecar and a 350 Honda would NOT suit a 300 pound sidecar to a 1500 cc Honda Gold Wing.

Universally adjustable fittings allow for an individual's riding style and normal loading of the sidecar, but be very suspect of any set of clamps that suggest they will fit all sidecars to all motor-

## 2. SETTING UP AN OUTFIT

cycles. Kits can be made to fit a small group of very similar bikes. Make all adjustments for lead, toe-in, lean-out, and leveling of sidecar frame before final tightening of mounting bolts. Any bolt should be finger tight removable. No connection should have any built-in pre-load or stress. Your machine is not set up correctly if you need a hammer to drive any bolt in or out.

All conventional rigs must be rigid. Play or movement between the motorcycle frame and the sidecar frame suggests something is wrong. Perhaps a loose nut or fitting, or perhaps the mounting struts are too weak. The cycle and the sidecar must act as a unit under all conditions. The only exception to this was for sidecar rigs used in the outback of Australia where roads were hewn dirt tracks. Here, the mounts were deliberately loose to absorb the road conditions. Otherwise, the frames of the motorcycle and/or the sidecar would break. The loss of stability was offset by driving less aggressively and the corners slower.

A fifth mount strengthens rigidity between the sidecar and the motorcycle, at the expense of a more complicated setup. Fit it after the rig has been properly aligned, near the rear upper suspension point and extend it downward and rearward to the sidecar frame. This mount prevents tail-wagging. The fifth mount helps when pulling a trailer from a sidecar frame mounted hitch. Some larger sidecars like the Watsonian Oxford or Cambridge benefit from the fifth mount.

# SIDECAR

## 2. SETTING UP AN OUTFIT

Type: FRAME MOUNT CLAMP REFERENCE CHART

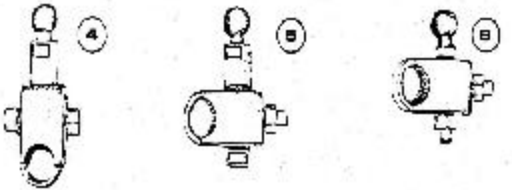
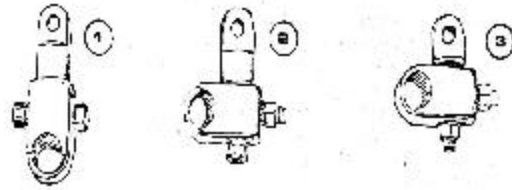

Clamp Size:

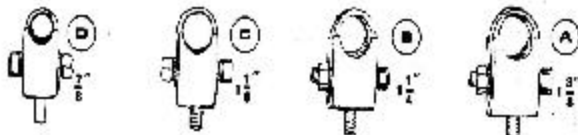

EYEBOLTS

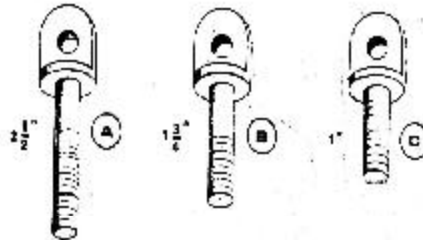

EYENUTS

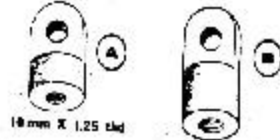

BALLSTUDS

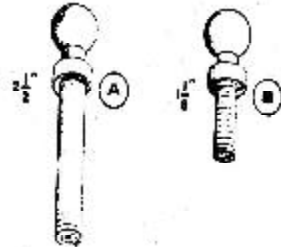

BALLNUT



all  $\frac{1}{2}$ " X 20 tpd

Copyright © 1978  
by Thomas L. Pedersen  
All Rights Reserved

### CLEVIS STRUTS ILLUSTRATION

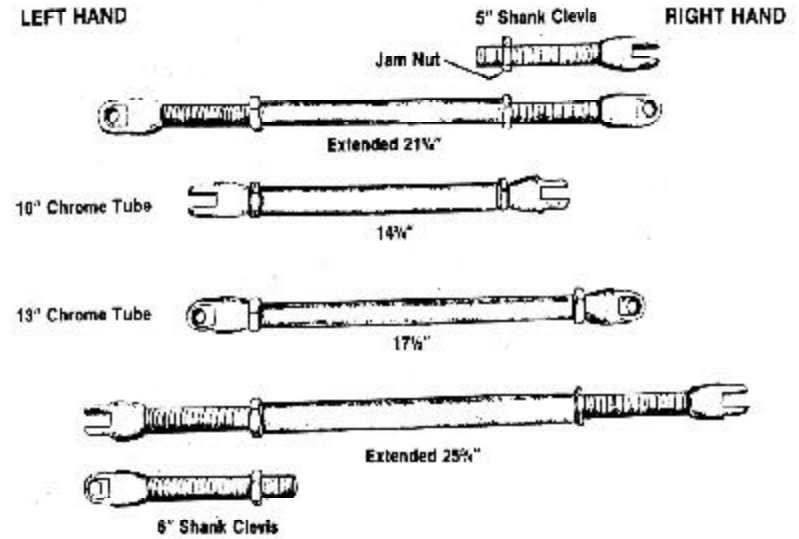

### COLLET MOUNT STRUTS ILLUSTRATION

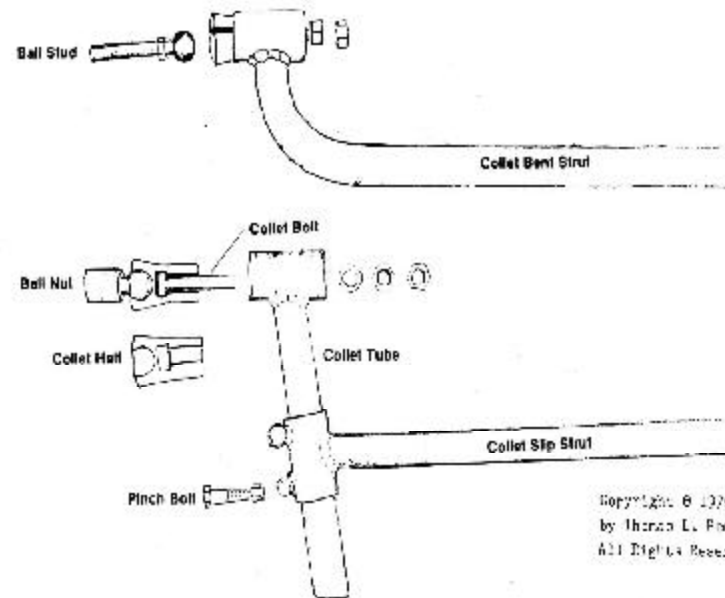

Copyright © 1978  
by Thomas L. Pedersen  
All Rights Reserved

## SIDECAR

### 2.4.1 Welding on Frames

Welding, unless done by a professional, can distort the frame and leave it in a weakened condition. If you must weld on the frame, preheat it, then normalize it after welding. This reduces distortion and possible brittle welds. Do not weld on a frame unless you are a certified welder.

### 2.4.2 What Not To Do

Some motorcycles use a small diameter rear frame extension for the seat. Never use this as a mounting point. Do not use the rear footrest support or the support for the exhaust pipe. It is poor practice to use the lower rear shock absorber attachment point on the swinging arm as a mounting point.

Existing motorcycle accessories may compromise ideal sidecar frame mounting locations. Correct placement of sidecar mounting points takes precedence over accessory items. Accessories include saddle bags, floor boards, crash bars and frame mounted fairings.

**NEVER CUT OUT A SIDECAR MOUNT OR  
INSTALL A FRAME MOUNT HAPHAZARDLY  
BECAUSE OF AN ACCESSORY.  
MOVE OR REMOVE THE ACCESSORY!**

## 2. SETTING UP AN OUTFIT

### 2.5 Brakes

You must allow for the additional weight of the sidecar and passenger. Most modern cycles, particularly those fitted with triple disk brakes, usually have adequate braking capability. If not, softer brake pad material can make the brakes more effective at the expense of greater lining wear.

Brake linings wear more rapidly with a sidecar than without. Check linings frequently. Replace riveted linings when 60 % of the lining remains. Bonded linings are fine until 40% of the lining remains. If unchecked, riveted lining will wear until the rivets protrude above the lining surface. Grooves then appear in the drum surface; an expensive situation to correct.

Brakes function by converting the forward motion into heat energy. Heat must dissipate quickly through the drum (and hub) for the brake to function efficiently. The lining loses its heat transfer ability as it wears.

Replacing a single-leading-shoe brake plate with a double-leading-shoe brake plate almost doubles your braking efficiency. This I have done with the rear brake of a 750 Laverda. You may even consider a wheel change also. Add a second front disk where only a single front disk exists.

Braking an outfit can be an unnerving experience for the uninitiated. On a solo machine, fear of a rear wheel lockup and consequent loss of control results in under use of the rear brake.

## SIDECAR

That is not the case with an outfit. You may use the rear brake more aggressively without loss of control. The rear wheel may lock up but with predictable results. Professional sidecarists put this to good effect. They can make a quick left-hander by locking the rear wheel and allowing the outfit to slide (easiest on slippery roads). Not for the novice sidecarist nor normal driving.

The soloist relies on the front brake for most of his braking effort. If the sidecarist locks the front wheel on a dry pavement, sidecar momentum causes the sidecar to swing forward damn quick. Coordinate your front and rear braking.

Some sidecars have brakes. The early H-D's, because of their weight and less effective braking, have a sidecar wheel brake. The brake mechanism matched the rear brake so brake imbalance was not a problem.

Most sidecar brakes do not have the same braking characteristics as the rear wheel brake on the cycle. A mechanical link connecting the sidecar wheel brake to the rear brake control pedal may lock the rear wheel with little sidecar wheel braking. Or the sidecar wheel could lock with little rear wheel braking. Both situations are bad.

Hydraulics can provide a reasonable braking setup. Use a proportioning device to control the hydraulically braked sidecar wheel if the rear wheel is hydraulically braked. Some with a dual front disk setup, rear hydraulic disk, and a hy-

## 2. SETTING UP AN OUTFIT

draulic sidecar disk prefer to drive the hydraulics so that one of the front wheel disks also controls the sidecar wheel disk, while the other front wheel disk is tied in with the rear wheel. Every combination has been tried and there are pros and cons to each.

Mixed drums and disks are difficult to control properly on a single system. Motovation uses a separate total braking system. The right foot operates the control located on the left side of the sidecar. The best location is near the rear brake pedal. With some dexterity, you can control the sidecar wheel brake, the rear brake, or both.

Watsonian also uses a mechanical drum with a pedal mounted onto the inner sidecar rail and operated by foot. I have also used the Watsonian drum brake operated from a hand lever control mounted on the left handlebar. Rarely will you use the clutch and the sidecar brake simultaneously. Normal Watsonian brake operation is by a foot control.

It is usually more trouble to fit a mechanical sidecar brake linked mechanically to the rear wheel brake control. It works but is difficult to set correctly.

Do not mount a sidecar brake control on the right handlebar. Easy access to your throttle control and front brake control are more important.

For those with an independent sidecar brake, use the brake in the following circumstances-

## SIDECAR

1. If the front wheel locks and causes the outfit to slew around. Releasing the front brake and stabbing the sidecar brake will correct the situation.
2. Apply the sidecar brake before entering a right-hander. This works as long as the sidecar wheel remains in contact with the road surface.
3. For severe braking, apply all brakes vigorously.

A better system uses the front hand control to operate one front disc and the sidecar brake. The rear foot control operates the other front disc and the rear brake. Make any modifications to the brake system with care. Check with the manufacturer. The master cylinder may not have sufficient fluid capacity for an additional brake.

### 2.5.1 Federal Regulations

Any changes in the braking system must comply with Federal Motor Vehicle Regulations and State Regulations. Motorcycle braking systems must have two independent means of control. A hand control and a separate foot control meet the requirements. A single master system is permitted if the hydraulic system has two independent hydraulic systems. Maximum braking distances are included for various speeds. Check the regulations carefully before making any changes.

## 2. SETTING UP AN OUTFIT

### 2.6 Lighting

Each State has rules about lighting but say little about sidecar outfits. Let common sense prevail regardless of the law for a particular light. Be sure the addition of such a light is legal.

Check items such as minimum and maximum height, intensity, location, and so forth.

The primary reason for having lights is for you to see where you are going at night. Another is for others to see you clearly.

Both are equally important.

#### 2.6.1 Instruments

A motorcycle with a sidecar needs more lighting than a solo motorc[cle. Some machines have adequate electrical power for solo operation but little reserve for the sidecar. Others have barely enough for the solo machine. A voltmeter and an ammeter show if an electrical system is satisfactory. They measure voltage across the battery, and net current flow into the battery.

With the headlight(s) and tail light(s) on, and the engine at fast idle, voltage should be greater than 12.6 volts. The ammeter should not show a discharge. A strong charging system may show

13.0 to 13.4 volts under these conditions. Fast idle is at 2000 rpm, equivalent to about 30 mph in high gear.

## SIDECAR

A very weak system may show 12.0 volts or less with consequent discharge. In this case, be careful NOT to overload your system. Better yet, try to find a stronger charging system, possible with some models.

At higher speed, from 2/3 to rated rpm, with or without lights on, voltage should never exceed 14.6 volts. Above this, expect rapid bulb failure, battery boil-over, or warped battery plates. This high voltage shows the voltage regulator is not working correctly.

Many cycles have only limited charging capacity which restricts added lighting. Can you still maintain a positive charge under normal city driving conditions when adding each component? If not, more lighting can cause electrical problems.

### 2.6.2 Running Lights

Running lights define the width of your vehicle and the direction you are proceeding at night-time. These lights are on the rear, front and side.

#### 2.6.2.1 Rear Lights

The location should be high, as close to the left side as possible, and located behind the wheel. Locate it higher than the frame. One place is the rear upper quadrant of the sidecar wheel fender. Another is on the left rear side of the body. Use a three-, four-, or six-candlepower bulb. This can

## 2. SETTING UP AN OUTFIT

be the smaller filament in a 21/3 or 18/6 bulb, with the larger filament used for the stoplight (see below).

The rear lens must be red. The taillight must light any time you operate the headlight.

### 2.6.2.2 Front Lights

The front running light should be located as far to the left and as high as possible. It should be at least frame high and in front of the sidecar wheel. One convenient place is the upper front quadrant of the sidecar wheel fender. Again, use a three-, four-, or six-candlepower bulb with a white or amber lens.

You still have many lights to go, and they must all be supplied from your limited electrical supply. Try the small bulbs first.

With all necessary lighting in place you may try larger bulbs.

Use a dual filament 21/3 or 18/6 bulb with the larger filament for your right front turn signal.

### 2.6.2.3 Side Lights

Your sidecar should be visible from the side. Choose your lights carefully. You should see the red light clearly to the rear, and white or amber to the front when looking at the sidecar from the right side. If not, install a small amber light to the

## SIDECAR

front and a small red light to the rear. Both should be as high and as far forward and rearward as possible. A three- or four-candlepower bulb is suitable.

Switch all running lights from the motorcycle's main lighting circuit. They must be on whenever the motorcycle taillight lights. They must light any time the headlight is on. Exception - Nothing is gained using the sidecar running lights in the daytime.

This is true even if you live in a State that requires the headlamp always lit. Few motorcycles have a surplus electrical energy.

### 2.6.3 Stoplight

The stoplight must be a red light of 18 or 21 candlepower, activated when applying either front brake or rear brake. This light may be included with your rear running light or separate.

Both should be located together. Use a single bulb with two filaments, or two single filament bulbs.

The additional stoplight on your sidecar will prevent you being rear-ended when braking. It supplements your existing stoplight bulb.

## 2. SETTING UP AN OUTFIT

### 2.6.4. Headlight

You must see clearly at night. Your front and rear running lights define the width of your outfit. An approaching motorist sees your single large headlight on the cycle, and your small running light near the curb. He may think you are a car with one headlight missing.

Always check you State Vehicle Code. Some States require an additional headlight fitted onto your sidecar. New York requires a separate headlight on the sidecar, for example. You may add a single or a dual filament headlamp to the sidecar.

The headlight on the sidecar should mount as far to the front as possible, as high, and as close to the left side as possible. Adjust the low beam, if used with the main headlight low-beam, so it does not glare into the eyes of oncoming motorists.

If the electrical system overloads during the daytime with the additional headlight, consider fitting a modulating device. These are legal under Federal law. Some claim the modulating headlight enhances conspicuity. Never drive at night with the modulating device in operation.

The tests made earlier on your charging system will determine if an additional headlight is practical. You can determine the maximum wattage bulb you can use. With a Honda GL i000 you can possibly add the equivalent of a 60/55 W dual beam Q-H bulb. An older BMW may not have enough charging capability.



## SIDECAR

For machines with lesser alternator capacity, use a single filament auxiliary lamp. Adjust it for maximum penetration and control it with a separate switch. Do not use it against oncoming traffic. Use this lamp for driving under foggy conditions. Use a filament size of at least 35 watts, up to 60 watts. Check your electrical system capacity. A Q-H bulb will provide more useable lighting than a regular bulb of the same wattage.

### 2.6.5 Turn Signals

The law in some States requires turn signals. Use turn signals whether required by law or not. Your present right-hand signals on the cycle are confusing at night. The following motorist knows you are turning but has no idea in which direction. Disconnect the right signals and replace them with turn signal lamps mounted on the right of the sidecar body. Use amber lenses to the rear and to the front.

Disconnect the lead to the right-hand motorcycle turn signal lamp but leave the lamp in place. It is ready when you remove the chair, and you have a spare bulb available in case of an emergency.

Flash rate must be at least one flash per second, and no more than two flashes per second. Ideally, at 1-1/2 flashes per second, the light should be ON about 50 percent of the time. The ON time can be from 30 to 75 percent at 1-1/2 flashes per second. If the flash rate increases, the maximum

## 2. SETTING UP AN OUTFIT

ON time may be as low as 60 percent. At slower rates the minimum ON time drops to 40 percent.

The turn signal and stoplight must be at least three times more powerful than your taillight or running lights.

Adjust flash rate by changing the size of the light bulbs used. Stronger bulbs, or replacing 18-watt bulbs with 21-watt bulbs, will increase the flash frequency. Conversely, replacing 21-watt bulbs with 18-watt bulbs will slow down the flash rate.

Turn signals -- 18 or 21 watt

Stop lamp -- 18 or 21 watt

Running lamps - 3, 4, or 6 watt

Auxiliary driving lamp -- 35, 40, 50, or 60 watts

### 2.6.6 Batteries

The use of a large auto battery instead of the small motorcycle battery has many advantages for the sidecarist. Placed behind the sidecar passenger seat and close to the sidecar wheel it provides a useful 35 to 50 pound ballast.

An auto battery with a warranty of 5 years is less expensive than a motorcycle battery with a six month warranty. The battery should be a sealed type. Place it in a leak-proof acid-resistant container secured to the sidecar floor. Cables, with adequate insulation, should be as heavy as those providing power to the starter motor.

## SIDECAR

Another benefit is the engine will start quicker and with less fuss when you try to start in zero or sub-zero weather.

The replacement battery must have the same voltage as the original battery. Battery polarity must not be reversed. Remove the motorcycle battery. This swap is for the dedicated sidecarist who will not often remove and replace his sidecar.

## 2.7 SUB - FRAMES

Some motorcycle frames are unsuitable for attaching a sidecar because they have no front down tubes. This is not necessarily bad. The fabulous HRD Vincent used the engine as a stress member. It also included a front lower sidecar mount in the nose of crankcase. Other machines in this category include the Laverda

750 cc twin, the Honda CX500, the Honda CBX, and so on. Install an adequate sub-frame if you use one of these models to pull a sidecar.

In my case, I chose to use a three point mounting, two uppers, and one lower for the Laverda. I also used a 4th mount onto the front of the crankcase to reduce the resultant sidecar wobble. The Laverda factory also fitted a sidecar onto the factory 750. Their subframe bolted to front of the massive quad frame backbone frame hidden by the gas/petrol tank. This extended down in front of and below the massive engine/crankcase and

## 2. SETTING UP AN OUTFIT

tied back into the backbone frame to the rear and below the transmission. They spent really big bucks on their subframe. It was far superior to my jerry rigged but workable solution.

A word of caution. Most motorcycle manufacturers state you invalidate their warranty if you attach a sidecar. This does not mean sidecar attachment is unsafe. It means the factory has not made a sidecar attachment. Nor have they driven it under every conceivable condition. They have no idea what would happen and no desire to find out.

If the failed component had no relationship to the sidecar, the factory would repair or replace it under the terms of their warranty. On the other hand, they would deny a collapsed wheel premature wheel bearing failure or clutch failure. Other items could be debated endlessly.

The BMW, a respectable hauler of sidecars for many years, is now in this category. All frames built since 1969 are for solo use only and will flex. The rear frame is of light tubing, attached by fasteners. The main frame is elliptical in cross-section. It is less strong in critical areas where you require strength for the attachment of a sidecar. BMWs make up about one third of our sidecar ranks and will receive special treatment.

The larger BMWs, up through the /2 series are sound machines for sidecar operation. Not so the later models built after 1969.

## SIDECAR

These require special sub-frames built by Motovation, EML, and other suppliers. Many sidecarists build their own sub-frames.

### 2.7.1 BMW Sub-frames: /5, /6, or /7 (Motovation)

#### 2.7.1.1 Top Mount

The top front mount is a simple heavy square tube stock. This clamps firmly to both down tubes near the head-stock with a means to mount the front upper mount.

#### Instructions

1. This mount consists of a 1" square tube cross-member which secures with two (2) special "U" bolts to both front frame tubes. It works with popular frame mounted fairings.
2. The cross-member attaches to the front surfaces of both front frame down tubes using the two (2) "U" bolts supplied. The clevis end threads into the right side end. Level the cross-member and tighten the "U" bolts to 45 ft-lbs.
3. Install the Type C eyebolt but do not tighten it fully. After attaching the sidecar, the angle of the eyebolt flats must match the clevis end mating with it. Use various thickness washers behind the eyebolt until it tightens at the correct angle.

The Mount is Complete.

NOTE- The BMW /7 frames have a cross member in this position. The size C#2 clamp is for the top front mounts.

## 2. SETTING UP AN OUTFIT

### 2.7.1.2 Lower Mounts Sub-frame

1. The lower mounts are in the form of a sub-frame. It attaches to the two lower motor mount bolts, the passenger peg gusset mount, and at the front of the frame. The last attachment uses a "U" bolt.
2. Remove the two nuts and washers from the lower motor frame mount studs. Position the "U" bolt around the frame tube.
3. Slide the sub-frame onto the motor mount studs while guiding the "U" bolt through the bushings. Replace the motor mount nuts and washers and install the washers and nuts on the "U" bolt.
4. Tighten the motor mount stud nuts so equal threads show on each side of the mount on the frame sides. Tighten the "U" bolt.
5. Drill a 1/2" hole through the rear passenger foot-peg gusset using the existing hole in the sub-frame as a guide.
6. Install the Type "A" Ball Studs using the nuts and lock washers at the front and rear positions through the sub-frame. Tighten all nuts.

The Mount is Complete.

See over.....

**BMW /5, 6 & 7 MOUNTING KIT**

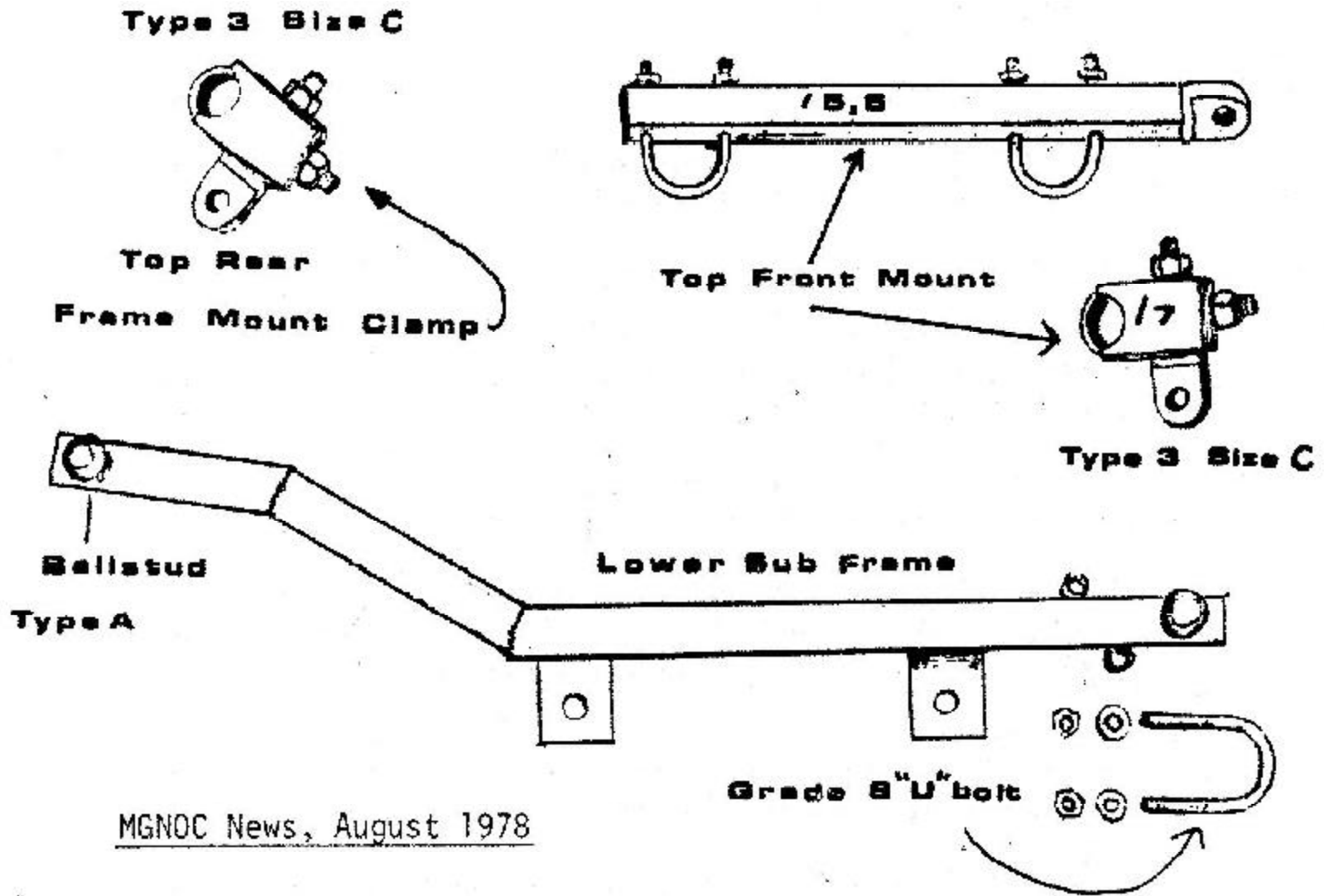

MGNOC News, August 1978

## SIDECAR

### 2.8 Notes from the Sidecar Experts

#### 2.8.1 Notes from Vern Goodwin

Vern has always been in the motorcycle and sidecar business. His Father started an Indian Dealership in 1934 and Vern's first rig was a 1939 Indian 74 with sidecar in 1947.

Since then he has sold bikes and designed and built more sidecars than he can remember. Now in semi-retirement Vern is a respected veteran Sidecarist who will work on your outfit or build you one if he likes the gut of your jib.

In Vern's experience, there are no two outfits that are exactly alike and the universal kits are anything but universal. Unless you get a H-D and put a H-D sidecar on it, or get Ural and put a Ural sidecar on it, you are very naive if you expect to get a bike from here and a sidecar from there and expect the union to be easy and inexpensive. Don't work that way.

Firstly, many universal mounts have a flat flexible strap that folds around a frame member and is secured by a mounting bolt that also secures the mount. It just cannot be tightened correctly. Either it is too loose, so it slips and rotates and your perfect alignment is gone. Else, it is too tight and squashes the bike frame which then develops a weak spot that is subject to breakage. Secondly, some struts may have upper RH threads and lower RH threads so adjustment is a real pain as one end must be removed entirely

#### 2. SETTING UP AN OUTFIT

before any adjustment in the overall strut length can be made. Thirdly, most accessible places to mount are not the best points for mounting. For these reasons the best mounting system is one purpose designed by a professional sidecar fitter who can fabricate whatever mounts are needed and knows exactly where to place those mounts.

The sidecar fitter must know exactly which model of which make and the specific year before he can even begin. From this he will know just where are the best mounting points for that bike. If he is not familiar with the specific bike he will need to see it in its naked form. That means without all that fancy plastic that now surrounds most modern machines. He must be able to get to the very bare frame. Either the plastic will come off and stay off, else a way is made to go through the plastic. There is no other way. Remember you are trying to create a single unit from two very separate units. Unless you can leave your bike for measuring, the sidecar installer must try to find one locally and make arrangements to begin measurements.

Then we come to the sidecar itself. How many mounts does it require? Where? 3, 4, more? Is it a match for your bike? A 120-pound CycleCar is no match for a full dress Harley yet it has been done with bad results. Likewise, a double adult Watsonian Oxford mated to a 350 Honda is just as bad. The sidecar should weigh about 30 percent of the weight of the bike you will put it on.

## SIDECAR



After the sidecar has been mated to the bike, you may then find that it does not perform. You may need to alter the rake or the trail of the front end, you may need to physically alter the rear-end ratio, you may need to change the rear wheel size, you may need to upgrade the electrical system, larger battery, more powerful alternator, etc. You may need to convert to a leading link front fork system, or to at least install a heavy-duty fork brace; you may need to install a friction or a hydraulic damper. You may need to install heavier fork springs in the front end or the rear suspension. Understand

## 2. SETTING UP AN OUTFIT

that not all these items need to be addressed on all sidecar rigs. It depends on what you plan to do and just how serious you are to get the maximum performance out of your rig.

The bottom line is that you do not put a bike and a sidecar together in 30 minutes, as some adverts would have you believe. While it can take six months or more to get a rig properly tuned, better plan on at least one or two real hard days work.

Goodwin's  
Electrical  
Adjustable  
Lean Control



### 3. HANDLING TACTICS

Motorcycle outfit handling is like flying a helicopter. It behaves unlike any other motor vehicle. It requires special skills not required for either single-track or two-track operation. It looks like a motorcycle, at least from the left-hand side, but it is steered like a car or truck. It has the stability of a sports car if turned in one direction, yet can be somewhat tricky if turned in the other. Like a canoe with a single outrigger.

Forget your old motorcycle skills and new ones. The more experience on two wheels the more training is required to be comfortable on three. The novice can become as competent as a two-wheel expert in a short time. The public-at-large rarely sees a sidecar (except in old movies). Many believe you can go only straight ahead and cannot turn in either direction. They do not understand; nor do they want to know.

#### 3.1 Advice for the Novice

A novice is anyone who is not familiar with a motorcycle sidecar combination. He may be a two-wheel expert or a car driver. He may be unfamiliar with any vehicle. Learning to drive an outfit can be unnerving and a shattering experience. It does not need to be. This manual is for the novice as well as for the serious student.

### 3. HANDLING TACTICS

A novice sidecarist, with his wife in the sidecar, pulled the sidecar over himself negotiating a left-hander (in England with the chair on the left). His wife died. A similar story happened in Montana where a novice sidecarist had his wife on the pillion and their baby daughter in the sidecar. At legal speed he pulled the chair over himself on a decreasing righthander on a narrow mountain road. The chair lifted, he straightened out to drop the chair, went across the road into the path of a semi coming down the hill. All on outfit were wiped out.

The United Sidecar Association received similar letters from novices asking for help. One reported he got into a gentle right-hander. He followed the advice of "experts." They told him to accelerate. He did. The chair began to lift. They told not to worry, just continue accelerating. He did. With the chair continuing to climb, he lost control. He crossed two traffic lanes and collided with the central guard rail. Fortunately, with no serious damage to his two children in the sidecar. The bike suffered major damage and he broke his shoulder. These stories, unfortunately, are all too common.

Acceleration on right-handers, is a technique only for the experienced and the professional. Slow down for a right-hander, at least until you know what you are doing. Know the limitations of your machine under all conditions and stay within them. That is what this manual, and especially this section, is all about.

## SIDECAR

### 3.1.1 Getting Started

An outfit, an extremely personal vehicle, is difficult for the novice to test ride. EML in Saint Louis may have a complete used outfit to test drive. Most sidecar manufacturers just have sidecars. How do you drive only a sidecar? Customers buy most sidecars by mail order or over the internet. When did you last see a complete new sidecar outfit at your local Honda dealer? He will do his best to warn you not to fit a sidecar as it will void any warranty. You may find a close but naive friend who will loan you his machine.

You will usually have a suitable solo mount before getting the urge for a sidecar. You have determined the best type of outfit for your needs and your machine. You either placed an order from a sidecar manufacturer or obtained one secondhand. By following the theory and alignment section of this manual, you have the sidecar fitted at last.

If you obtain a new sidecar from a manufacturer, he will supply the correct fittings for your particular machine, we hope. You may have to make some attachments if you got the sidecar from another source.

It is a big advantage if you know a welding expert, an expert machinist, and a veteran sidecarist to assist if required. Now you are ready to continue.

## 3. HANDLING TACTICS

### 3.1.2 The Controls

Make sure you can find all functional controls without the luxury of looking for them. You must be familiar with brakes, clutch, lights, throttle, choke, horn, flasher, and how to use them. Any delay in searching for a control, or the improper use of that control is a potential hazard to you.

Next, while sitting astride the cycle, make sure you can reach and operate all controls. Your body requires a different riding position on an outfit. You will rarely need to adopt the prone position—often seen on the road by soloists. You will not lean the machine although you may use body English in cornering. You will need to turn the handlebars easily, quickly, and often. A near vertical body position is the most comfortable.

Make changes in handlebar and footrest positions so you can operate all controls easily and safely. Make changes in control locations to suit you. For example, some machines have a choke control mounted below the tank. With a full fairing fitted this can be awkward. This control can fit on the handlebar using a longer cable.

### 3.1.3 Going Straight

You are now ready for preliminary road testing. Have a friend drive you to a large deserted parking lot. You need your friend, or a 75 pound ballast in the sidecar when you take over.



## SIDECAR

### Exercise 1

Practice starting and stopping in a straight line. For the first exercise, use only low gear. Accelerate to about 1/4 to 1/3 rated rpm, hold it a short while, then slowly stop with only a light touch on the brakes. Do not make any violent or sudden turns to left or right. Repeat until you are confident of this maneuver.

### Exercise 2

For the next exercise, change from low into second, then third (if space permits), then back to second, and back to first. Become familiar with how the machine behaves when you accelerate and decelerate. You may notice the outfit to drifts slightly to the right while accelerating, and to the left while decelerating. This is normal and no cause for alarm.

Grip the handlebars firmly. Soon you will automatically apply the correct counter thrust to keep the forward motion straight.

### 3.1.4 Front Wheel Wobbles

You may find a surprise. Some outfits tend to shake their head at speeds typically between 10 and 30 mph while decelerating. Other machines show this at higher or lower speeds, or while accelerating. Some do not have any headshaking. The reason is explained elsewhere.

## 3. HANDLING TACTICS

The cure is simple. If you have a friction damper, adjust it for minimum flutter and easy steering. Know when to expect this flutter. It easily controlled by firmly grasping both bars and not allowing the wobble to start or persist. If a friction damper is not fitted you can use an hydraulic damper. The damper must not be too large nor restrict steering movement or front suspension travel.

If wobble is excessive, try to find its cause. It may be a front tire out of balance, a crooked front wheel, or not enough damping.

These are easy to fix. It may be incorrect front fork rake, not so easy to fix. Another cause is inadequate linkage between the cycle frame and the sidecar. Correct this situation before the outfit is safe to ride.

### 3.1.5 Checking Alignment

The next check is the alignment. At a constant speed of about 30 mph on a straight level surface you should have no pull on either handlebar. The steering should be fairly light and precise.

A noticeable drag to one side or the other shows misalignment. Correct this before proceeding.

Misalignment will make your machine very tiring to drive and it will not handle properly. Your tires (especially the rear) and rear chain will have a very short life. A rear tire can scrub bald in less

## SIDECAR

than 1000 miles if alignment is wrong. The rear tire may last 10,000 miles or more if alignment is correct and you have the correct tire.

The outfit may steer straight (not pull) even if misaligned. For example, the cycle may lean inward giving a right pull which is offset by excessive sidecar wheel toe-in. Or the outfit may lean outward and the sidecar wheel may have zero toe-in or some toe-out. In either case, excessive tire wear results even though the outfit does not seem to pull.

### 3.2 Basic Skills

A motorcycle with sidecar, when viewed from the left side, looks like a solo motorcycle. This resemblance is superficial.

Gyroscopic forces and momentum keep a solo upright at speed. It behaves as a single track vehicle. The outfit, because of the sidecar, is naturally stable when going straight ahead. It is a two track vehicle. It is when turning that the basic differences between a solo and an outfit appear.

Any object which travels in a circular path generates a centrifugal force. Those who studied physics may recall that:

$$F = C.M. (V*V)/R$$

In everyday language, the centrifugal force generated,  $F$ , increases as the speed or the velocity,  $V$ ,

## 3. HANDLING TACTICS

increases. It also increases as the turn radius,  $R$ , is reduced. The mass,  $M$ , of course, does not change.

If you reduce the radius from 400 feet to 200 feet, the centrifugal force doubles. If you increase speed from 20 mph to 40 mph, the centrifugal force quadruples, ( $2 \times 2 = 4$ ), not doubles. A relatively small increase in speed increases the force a large amount.

A solo rider offsets centrifugal force by leaning the machine into the direction he wishes to turn. The faster the speed or the tighter the turn, the more he leans the machine over. Racers lean their mounts over until their knees almost touch the pavement. A sidecarist cannot lean his machine. His sidecar outfit behaves like any rigid two-tracked vehicle.

One point may not be obvious to the solo rider switching over to a sidecar outfit. The next time you're on a solo bike try to take a left hand corner by steering the handlebars left. Try it again with a right hand corner. You'll notice something odd.

You steer or push the bars right to go left and you push them left to go right. You do not start the corner by steering the handlebars left for a left turn and vice versa. As the motorcycle starts to lean into the corner, the handlebars may go left for a left turn but you will not be "pushing" them in that direction. Your bike turns more by leaning than by steering.

## SIDECAR

Once in a left turn, if you desired to turn a harder left, you'd push the bars right. The bike would respond by leaning farther left, then turning harder left.

When you mount on a sidecar rig after many years of solo riding you may think that it a breeze. You don't have to put your feet down at a stop. The next thing you know, you must steer right to go right and steer left to go left. You know "that is the way it's always been, but it feels weird. It must be that weird contraption on the side. The "weird feeling" is you've been steering left to go right and right to go left on [our solo motorcycle all these years. Remember how "weird" it was when learning to steer a bicycle the opposite from the way you want to go? You must forget all that. From now on you must steer in the direction you want to go.

### 3.2.1 Right-Handers

As you turn to the right you generate a centrifugal force. This force acts horizontally through the center of mass and at right angles to the direction of travel. It acts outward from the center of radius of the turn. The center of mass of an outfit is between 6 inches and 12 inches from the center line of the motorcycle to the right. It is about 15 inches to 18 inches above the road surface. It is back of the center-line between the front and rear wheel of the motorcycle. The position varies with the loading of the outfit.

## 3. HANDLING TACTICS

This force generates an overturning moment force around a pivot line between the front wheel and rear wheel pavement contact points. The moment force is the centrifugal force multiplied by the height of the center of mass above the road.

At very low speeds the machine is not unstable because of the normal restoring force or restoring moment. This force is the mass or weight of the machine, sidecar, driver, and passengers. It acts vertically through the same center of mass.

The size of the restoring moment is the mass multiplied by a horizontal distance. This distance is between the center of mass and the line between the front and rear wheels, measured at right angles.

As long as the restoring moment is greater than the centrifugal moment, the sidecar wheel is in firm contact with the ground. At point of balance, the sidecar wheel just floats above the ground.

When the centrifugal force exceeds the restoring moment the sidecar wheel becomes airborne.

NOTE- the overturning moment and the restoring moment are in opposite directions around the same axis, the pivot line.

That's it. How simple! Failure to understand these basics has led many beginners and some experienced riders to grief and sorrow.

## SIDECAR

If the chair rises you probably entered the right curve at a speed greater than the posted speed limit. We normally ignore posted speeds on curves on a solo motorcycle or when driving a car. Ignore them while driving a sidecar outfit at your peril!

Some suggest you can "drive" the motorcycle around the sidecar when making a right turn. This is an advanced technique covered later. The beginner must always slow down before the turn. He must not attempt to drive the sidecar through a right hander.

We show, later, an advanced technique using this principle. The outfit is a rigid machine. The motorcycle is not just driven "around" the sidecar.

The sidecar lifts when the centrifugal force moment becomes greater than the restoring moment. Reduce the centrifugal moment to drop the sidecar. Reduce speed, or straighten out the curve (increase the radius of curvature), or both.

Another technique uses body English. Throw your weight to the right while pushing down on the left footrest. This helps getting better weight distribution for a right turn. Recognize the limitations of the outfit. Enter curves slowly and under control. It is often difficult to regain control once lost.

## 3. HANDLING TACTICS

### Application of theory-

Select a large open lot with no obstructions. If there is a single lamp post, Finegan's law says that you will hit it. Have a passenger, or at least 100 pounds of ballast in the sidecar before you begin.

### Exercise 3

Find an area of about 100 ft by 100 ft. Lay out a 50 ft circle with about 10 equally spaced safety cones. The small cones are adequate.

Drive the 50 ft diameter circle clockwise to create the right turn effect at a low speed. Slowly increase speed, maintaining this radius. Continue increasing speed slowly as you feel confident. Do not go fast. Let caution and common sense be your guidelines. At some point you should feel the sidecar just begin to lift. Do not go faster.

That is your limit for these conditions. If the sidecar suddenly rises too fast, straighten out and reduce speed by rolling off the throttle. Then try it again, but more slowly this time.

### Exercise 4

Reset the cones to a 35 ft radius and repeat as above using the tighter turning circle. The chair begins to lift at a much slower speed.

## SIDECAR

### Exercise 5

Reset the cones to a 25 ft radius and repeat as before using the tighter turning circle. The chair begins to lift at an even slower speed.

### Exercise 6

Unload the passenger and repeat Exercise 3 but now with just 50 pounds of ballast. Note that the sidecar now lifts at a lower speed for that turning circle.

### Exercise 7

Finally, repeat Exercise 3 with no ballast. The sidecar lifts at a lower speed than in Exercise 6.

### Optional Exercises

Repeat Exercises 4 and 5 with 50 pounds and with zero ballast until you can predict with some certainty at what speed it takes for a given sidecar loading. When it becomes second nature you will have mastered this segment.

### Exercise 8

Now repeat Exercise 3 but with your passenger now seated behind you on the pillion. Note that the sidecar is very easily picked up when turning to the right.

## 3. HANDLING TACTICS

In summary - if you have a passenger, for your sake and his/hers, place your passenger in the sidecar and not on the pillion.

If he places his ballast in the sidecar, his performance is down, his gasoline consumption rate up, but he can make harder and faster right-handers. If he hangs this ballast on the pillion seat he will make better time on less gas but may have some hair raising right-handers.

He has discovered that the location of the center of mass makes a big difference. It should be low, and as close to the sidecar wheel as possible. Always put the first or heavier passenger in the sidecar, not on the seat behind you.

### 3.2.2 Left-Handers

Use the same setup as for Exercise 3.

### Exercise 9

Drive in the 50 ft circle anticlockwise to simulate the left turn at a low speed. Increase your speed slowly and continue until you feel very confident. Do not drive fast. Do not exceed 40 mph.

### Exercise 10

Reduce the circle to 35 ft and repeat until you feel very confident. Do not drive fast. Do not exceed 40 mph.

## SIDECAR

Carefully develop your riding skills. Note how the different speed or circle size affects you.

The centrifugal force that caused the chair to lift on a right-hander also acts on a left-hander. The pivot line is now an axis between the front wheel and the sidecar wheel. It is possible, on a sharp fast left-hander, to cause the rear wheel to lift. Unlike lifting the sidecar wheel, the rear wheel can lift quickly and with little warning. Too much lift can cause the rig to flip completely over. Fortunately, with a well aligned and balanced outfit, it is difficult to pick the rear wheel up.

**NOTE: NEVER TRY TO PICK UP THE REAR WHEEL DELIBERATELY.**

### 3.2.3 Right-Handers While Accelerating

If you have some experience driving a sidecar, there is a way to make a safe righthander at a slightly higher speed.

If you have an independently controlled sidecar brake, and you begin to feather the sidecar brake just before entering the corner, you can set the sidecar to just drag a little to the right which can aid your progress through the righthander. This technique is used in conjunction with the technique that follows. It is effective when weight is on the sidecar wheel. The force on the sidecar wheel decreases as the centrifugal force of the turn builds. It has no effect when the sidecar wheel is air light and above the road surface.

## 3. HANDLING TACTICS

If you can also shift your weight off to the right, and at the same time slightly feather the front brake, while opening the throttle, this combination will add a little to overcoming the effects of centrifugal force and permit a slightly higher speed on turning. However, this is a far more advanced technique so is not on the list of approved exercises. Do not attempt if you feel uncomfortable. The best practice is to stick to the posted speed limits when turning, and slow down before entering the turn.

### 3.2.4 Right-Handers while Power-sliding

This technique has no place on the street. It is mentioned only to complete your understanding of sidecar dynamics. Under racing conditions, or on off-road tracks, a sharp righthander can be made by dropping down a couple of gears and opening the throttle wide. This breaks the traction loose at the rear wheel and causes the rear to power-slide to the right, especially when the front wheel is turned sharply. Again, no exercises are given.

### 3.2.5 Right-Handers taken to Instability

In this technique, you will be flying the chair. Some might consider that any time the sidecar wheel is off the ground that the sidecar is flying. However, there is a big difference between flying with the sidecar wheel just an inch or so off the ground, and flying the sidecar with the sidecar wheel pointed skywards and with the entire rig

## SIDECAR

almost out of control. The former condition might be considered as aggressive driving, however, the rig is under total control with normal steering. The essential point is that the CoG of the rig is to the right of the tipover line between the front wheel and the rear wheel. There is a positive gravitational force holding the rig down which is balanced against the overturning centrifugal force.

However, the faster the speed or the tighter the turn the higher the rig will lift and it will eventually approach an unstable condition. This is because the CoG is now fast approaching the tipover line. When the CoG is exactly over the tipover line the rig is unstable. Drop the speed a little and the rig falls. Increase the speed a little and the sidecar will climb over the bike. Open the turn a little and the rig falls. Tighten the curve a little and the sidecar will climb over the bike. You are in a very delicate balance situation. This is the cause of the most horrific sidecar accidents. The driver did not slow down but entered the corner too fast. The sidecar climbed over him. He straightened the curve a little bring the sidecar down and in doing so crossed over into the oncoming traffic as the road was turning to the right with deadly results. Directly into the path whatever oncoming vehicles there were. Yes, that driver was really flying the chair just before impact!

## 3. HANDLING TACTICS

### 3.2.6 Flying the Chair and Steering Reversion

Now you know how to get the chair up into the air some of the more advanced sidecarists might want to develop this skill for exhibition at a campground. Do not use a wide-track heavy chair. Do not carry a passenger. Use a light chair with a narrow track. The chair will lift easier and you can control it better. You are trying to convert your sidecar rig into a very off-balanced two-wheeler. Be sure you have a large open and uncluttered area to work in.

As you gain speed turn to the right while throwing your weight to the left. You should be able to pick up the light chair at a fairly slow speed. Now, with the chair up to the balance point you will notice a drastic change in handling. Up to this point, to go right you turned right. Now, with the CoG directly over the tipover line your rig behaves as if it were an unbalanced single-track vehicle subject to steering reversion. You can straighten out the rig and continue in this very unstable condition, even speeding up, or slowing down, and swerving to the right or swerving to the left. This, again, should never be tried on the public street, unless you are in an organized parade and have practised this trick many times on a special rig for this purpose.

Remember, this trick is exactly the same as driving your family auto on its two left wheels. It can be done, and you know why, but why bother. It will not enhance your on-road driving skills.

## SIDECAR

### 3.2.7 Negotiation of Left-Handers at Speed

It is still not a bad practice to slow down before ANY turn and accelerate through the curve. For lefthanders it is very important that any movable weight, ballast, passenger, be as far to the rear of the sidecar as possible.

There is danger of flipping at high speed while negotiating a curve with the chair on the outside. The best technique is to enter at a higher speed, roll off the throttle, and allow the outfit to slew left. Again, the delicate balance of knowing just how fast you can enter and how rapidly to lose speed is important.

The dangers of excessive speed are two-fold. If power continues through a tight left-hander, the rear wheel can lift and throw the cycle over the outfit. This is embarrassing at low speed but dangerous at high. You may realize you are entering at too high an approach velocity and instinctively lock the front brake. This can cause the sidecar to swing around so fast it will make your head swim.

It should only be necessary to roll off or play with the throttle for either left-handers or right-handers. However, lightly touching the front brake for right-handers or the rear brake for left-handers, can aid your progress through the turns.

## 3. HANDLING TACTICS

### 3.2.8 Right Angle Turns

The next skill is our right angle maneuver to left and right, as in any turn you would make at any urban intersection. In this case, begin with a very sharp corner at just over walking speed. Increase the speed slightly until you find the maximum speed you can turn sharply. Then make the turn less sharp, such as crossing one lane of traffic while turning, and repeat the procedure. When turning to the right it is an instant failure to drive the sidecar wheel over the cones that represent the curb or sidewalk. It is extremely important that the driver know exactly how far his sidecar wheel is to the edge of the road at all times, both for his safety and for the safety of the public at large. The driver will also lose points if, during the execution of this procedure, the sidecar wheel is more than one foot from the curb, unless there are drainage holes, potholes, or other debris that would imperil his progress.

When turning right from a 2-lane 2-way road into a 4-lane 2-way road, always turn into the lane closest to the right curb. If you want to move into the left lane later, do so following the steps on lane changing.

When turning left from a 2-lane 2-way road into a 4-lane 2-way road, always turn into the lane away from the right curb. There could be a motorist who wants to turn into the road at the same time you do. Move over later when safe to do so.



## SIDECAR

### 3.2.9 Driving in a Lane

Your width is about the same as a standard automobile. Unless there is some valid reason not to do so, always ride in the center of the lane. If you stay to the left or the right you invite someone else to try and get into your lane with you which can create a hazardous situation.

If you are driving in the curb lane and there is a walker or a cyclist near the curb, then move over to the left as far as you can and slow down. If the lane is narrow and you do not believe that it is safe then go into the next lane over, if there is one, or slow down even more. The few minutes saved by not slowing down will be as nought should there be an incident which would delay you perhaps several hours. In some states there are safety rules that require/allow a cyclist to be given a six foot space cushion around him at all times - at least - so an avid cyclist maintains.

Always maintain an absolute minimum of 2 seconds space between you and the vehicle up front. On the open road, you can safely open this up to 5 or even 7 seconds. Do not allow yourself to be tailgated. You may speed up to the posted speed limit if you are driving at a lower speed. You can tap your brakes and trust he gets the point - but do not antagonize the driver. You can slow down if you are in the curb lane and trust he will overtake and pass you. Or you can pull over into the curb lane and allow him to continue. But do not allow him to continue on your tail.

## 3. HANDLING TACTICS

### 3.2.10 Lane Changing to the Right

Make a practice to pick your lane and stay there. Peace officers do not always go after the fastest drivers. They go after those who stand out, those who constantly cut in and out of lanes causing others to brake rapidly to avoid them and who are then in danger of being rear-ended by another behind them. If you plan to exit the freeway, get into the curb lane perhaps a half mile or a mile beforehand. Do not wait until you are almost at the exit then cut across three or even four lanes of heavy traffic to exit amid squeeling tires and angry fists. You also take the risk of overshooting your exit, and the risk of creating a major pileup.

When you wish to change into the righthand lane, use your mirrors wisely. First glance into your left mirror to verify there is no one there to surprise you. Then take a good hard look into the right mirror to make sure the space you intend to go into is clear. Look behind you. Is there someone back there about to shoot into the now open space. Look at the lane two lanes to the right. Is there someone there who looks like he wants to get into the open space. Always mentally note where everyone is at all times and mentally try to determine what it is they are going to do. With a little practice you can be right most of the time. When the space is clear, and you have a fair indication it will remain free, gently turn your bars to change direction and straighten it up.

## SIDECAR

### 3.2.11 Lane Changing to the Left

Changing lanes to the left does carry more risk than changing to the right. Traditionally, the left lanes are for the faster drivers. Some places allow you into these lanes only to overtake. Typically, those you overtake on the right do so at a slower pace, typically whatever the nominal speed is in that lane. However, in the left lane it is whatever the traffic will bear. You glance back to the right and it appears clear. Then you as glance to the right there goes a speedster past you in a flash.

Stay out of the leftmost lane unless you are about to overtake a slower vehicle in your lane, or if your exit is off to the left. This situation often occurs in main roads. Glance to the left and behind to read the road and to know where everyone is. Take a good hard look to the left to ensure there is no one who will be in the spot you intend to take. If your mirrors vibrate, then turn your head entirely around. If you have a full face helmet or if your neck is stiff you might not be able to get a good look at what is coming down behind you. So, get your mirrors fixed at the earliest opportunity, and make sure you do have ANY blind spots.

When ready, gently turn your bars to the right, and straighten them into the lane. Never pull out right in front of an overtaking vehicle and beat him to the punch by fast acceleration. He may not want to brake or slow down to avoid you.

## 3. HANDLING TACTICS

### 3.2.12 ZIP-WHIP Lane Change

You can do whip lane changes only on a motorcycle sidecar rig. The unique character of the unbalanced rig allows the driver to whip the rig from the left lane into the right lane extremely fast. To attempt this on a single track vehicle requires that the vehicle be leaned into the curve, straightened, then leaned over the other way. A car, with its longer wheelbase, just cannot be whip lane changed so you can for a sidecar.

The sidecar will begin to rise as soon as this manoeuvre is begun. However, the driver then wrenches the front wheel ahead, effectively beginning a sharp left turn and drives the sidecar wheel back down. The whip change can also be made from the right lane into the left but is more tricky as the right turn segment comes at the end of the manoeuvre which leaves the sidecar up.

So it can be done. What will it do? It will create animosity between you and your other road users. It only takes one to feel the slight and he will take whatever risks he can to see that you are taught a lesson. It will also bring you to the immediate attention of the nearest peace officer who will insist on writing you a ticket even though you were not speeding, such as improper lane changing, too fast for conditions, following too closely, and a half dozen other charges before he is finished. I know from experience. Cop said he had never seen a whip lane change like that. Still got to pay. So, reserve this technique for the range.

## SIDECAR

### 3.2.13 Braking

Unless advised otherwise, do all braking tests while going straight ahead. Brake from a moderate speed using only the rear brake lightly. Repeat, but use the rear brake more severely. Continue until you lock up the rear brake. There is no tendency to slide right or left, even with the rear wheel locked, as long as you are going straight ahead.

Now while decelerating hard (rear wheel locked), turn handlebars slightly to left. Be ready to recover instantly (straighten handlebar and get off the brake). The rear end can swing around very fast. It will swing around more dramatically on a wet or greasy road. Never use this technique for normal driving. For now, master it, for it may be useful some day.

Now brake using the front wheel only but DO NOT lock the front wheel. You will find that the chair has a greater tendency to swing around, the harder you brake. Continue practicing using both brakes. Soon you will master proper synchronization of front and rear brakes for maximum deceleration under full control.

A sidecar brake can be good or bad. Use an independently controlled sidecar brake to advantage for right-handers. By applying the sidecar brake gently before entering the right-hander, the outfit will begin a slight crawling action to the right. This is the direction you wanted to go anyway.

## 3. HANDLING TACTICS

Keep the sidecar brake on during the turn for as long as necessary. Of course, this technique ceases to be effective when centrifugal force causes the sidecar tire to lose contact with the road.

The sidecar brake can be one of several types. It may be installed by the manufacturer, it might have been added by another with parts obtained from the manufacturer, or it might have been from a third party source.

The brake itself might be a mechanically operated drum brake, a mechanically operated disk brake, or a hydraulically operated drum or disk brake. If a drum brake it is likely a single leading shoe but might be a double leading shoe if the wheel was built from a motorcycle front wheel. Most sidecar wheel brakes are woefully inadequate, but there are some very good sidecar brake systems, especially the later hydraulic disk systems.

If mechanical, they may be operated from an auxiliary foot pedal mounted on the sidecar, or bolted to the right side of the bike. In some cases the linkage is tied to the rear brake's mechanical linkage. This is not a very good system. The sidecar brake might also be operated from an auxiliary hand control, typically on the left handlebar just under the clutch. Rarely is the brake and clutch needed at the same exact time.

A more effective braking system is where you have a totally hydraulic system. Here, if you have a large enough reservoir and a proportional valve,

## SIDECAR

you can tie the rear brake in with the sidecar brake allocating about one-third the force to the sidecar wheel and about two-thirds to the rear wheel.

Another popular method is to tie one front disk to the rear disk, and to tie the other front disk in with the sidecar wheel, again with a 3:1 force splitter.

Each type of brake system will behave uniquely. Practise until you feel you can master stopping under all conditions, including around a curve to the right, around a curve to the left, down a hill, up a hill, with and without a passenger or heavy ballast.

When going downhill, always change down and use your engine as a partial brake. Be very sure not to exceed posted speeds especially on right-handers. You simply have no safety margin.

### 3.2.14 Practice

Having achieved these skills on dry pavement, try these skills on loose sand, gravel, mud, ice, snow, and wet concrete. With each new type of surface, always, begin with simple maneuvers at slow speed. Gradually work up and develop your potential. Each type of surface requires a separate skill. Never over-extend yourself.

Clearly think out what you want to do and how you will do it -then do it safely.

## 3. HANDLING TACTICS

Keep practicing until it does not require conscious effort, yet you put it together subconsciously. Now you can leave the beginner's circle and become an amateur sidecarist.

Just don't try to get there too fast.

### 3.2.15 Tips for Handling

- The further forward the sidecar wheel the less the cycle will pull right (running around the sidecar) when accelerating. However, this also contributes to the scuffing and wear of both the cycle rear tire and the sidecar tire.
- The greater the sidecar wheel toe-in, the less pulling to the right. Too much toe-in and tire wear increases again.
- The vertical lean of the cycle determines how easily the sidecar lifts off the ground on a right-hand turn. Lean-in (toward the sidecar) helps hold it down. The lean also affects pull to the right on a high-crown road. Lean-out (away from the sidecar) increases left pull. Extreme left lean moves the contact patch of the tire to the left side.
- The greater the weight of the sidecar, the more the sidecar lags behind the cycle when accelerating.
- Soft sidecar suspension worsens handling. Adding a sidecar passenger causes the unit to dip to the left. The outfit wallows on sharp turns. Use stiff sidecar suspension for good handling.

## SIDECAR

- Firmer cycle suspension (shocks and springs) compensates for the added weight of the sidecar and passenger.
- Head-shaking or front-wheel wobble, usually at slow speeds, may occur with a sidecar outfit. Tighten the friction steering damper, if fitted, or add a hydraulic steering damper if not. Worn swing-arm bushings or shocks aggravate wobble. Low front tire pressure can cause head-shaking.

## 3.3 Advanced Skills

### 3.3.1 Independent Braking Techniques

The eccentric imbalance of an outfit suits independent braking. Take right-handers more easily by entering at a lower speed. Apply the sidecar brake just before the curve to start a right-hand drift. Then roll-on the throttle to get the rear wheel slightly broad-sliding outward while lightly braking the front wheel. With practice it comes easily. Do not attempt this with a low powered machines or with a light sidecar.

If you have a high powered machine with a hard flat-profile tire on the rear wheel you can power-slide into a right-hander. Perhaps you have a willing passenger leaning outwards?

For left-handers, roll the throttle off and brake the rear wheel. You can also power slide into a left-hander if your rig is properly balanced, your racing techniques perfected, and your passenger also an expert. Not for street driving.

## 3. HANDLING TACTICS

### 3.3.2 Lifting the Chair

The sidecar wheel always remains on the ground during normal driving. You can for drive long distances at slow speed with the chair in the air for special occasions (parades). The chair should be fairly light and have a narrow track. The chair lifts much easier without a passenger.

To lift the chair, turn sharply into the chair to get it airborne. Once lifted, continue leaning until the center of gravity is directly above the front and rear wheel ground contact. Now you can drive as long as you want in a straight line.

To turn left or right, handle the rig as you would a solo. As long as you are on two wheels you can use all the solo tricks, including counter-steering. Or lean more to left to turn left. Or ease up to turn right. A trick bike suitable for this style of driving is not normally suitable for street use.

A rule of thumb will determine if the outfit has sufficient stability for general street use. Stand on the left footrest with your body weight on your left foot. Firmly grasp the handlebars. Swing your weight to the left while pulling up on the right handlebar and pushing down on the left. If the chair does not lift, or lifts sluggishly then drops firmly back to the ground, it is stable. If it lifts easily or comes up and stays up, it is unstable. Use it only for low speed parade demonstrations. Or add 50 to 80 pounds of ballast and try it again. Do not drive an unstable unit on the highway.

## SIDECAR

### 3.3.3 Rough and Slick Surfaces

An outfit will go where few two- or four-wheel machines can go. Unlike a solo rider, an outfit driver has little fear of ice, snow, or oil on the pavement. He does not fear wet manhole covers, loose sand, gravel, mud, or pot holes.

The outfit handles well on fresh snow. With a rear tire chain, it performs on glare ice. Special nail studded tires make ice racing possible. Only the softest of mud will halt an outfit. (I have driven in mud so soft the rear wheel sank six inches below the "road surface") .

Use knobby moto-cross tires for snow and mud. Trials or universal type tires are good all-round sidecar tires. Avoid high profile racing tires. You do not need sidewall contact.

### 3.3.4 Hills

Sidecars are not normally used for hill climb events. With suitable gearing they will climb well. Never lug the engine down. Always change to a lower gear before the engine tells you to. Take advantage of engine braking by using lower gears when descending steep hills. You have more control than if you relied on your brakes. Never coast down a hill with the transmission in neutral. Never coast by pulling in the clutch lever.

## 3. HANDLING TACTICS

### 3.3.5 Parking

You have no fear of finding your outfit has sunk into the sand or fallen over on hot asphalt when you return. You may or may not need a parking brake.

\*A two-wheeled motorcycle initially sold with a sidecar attached, or intended to be so sold, is a three-wheeled motorcycle for purposes of compliance with S5.1.4 of the Motor Vehicle Safety Standard No. 122, Motorcycle Brake Systems.

This standard applies to all motorcycles with sidecars attached and sold in the United States since 1974. Most sidecars are fitted as an after-market "accessory" and therefore do not need to comply with S5.1.4 of MVSS No. 122. \* Frank Berndt, Acting Chief Counsel, U.S.D.O.T.,NHTSA, private letter to H. A. Kendall, March 15, 1979.

Most outfits do not have a parking brake.

Make sure you leave the outfit in low gear when parking on a hill. If a curb exists and you are parking up-hill, allow the outfit to slowly drift backwards at an angle until the sidecar wheel is against the curb. Pull the clutch in to make sure the outfit will not roll. If possible, lock steering with the wheel pointing to the right to be sure the outfit will not accidentally roll backwards.

Most outfits have no reverse gear. A few older H-D's and some old Indians do. So does the Russian Neval and the new Honda Gold Wing 1500.

## SIDECAR

Don't park facing downhill with the sidecar wheel hard against the curb. You will need to push the outfit back up the hill by hand before you can swing out. When did you last push a 950 pound H-D without reverse up a 1"3 grade?

If you suspect the engine may turn over even with the transmission in low gear, use a strong cycle wheel chain lock for added security. Better still, find a better place to park. If all else fails, make a U-turn so you can park up-hill as described above.

### 3.4 Wobbles

Many outfits exhibit a characteristic head shaking at low to moderate speeds, usually while decelerating. The severity of the shakes can be quite mild or can be a tank-slaper. An out-of-round or improperly balanced front wheel may be the cause. So can loose steering head bearings, a worn swing arm mounting, or frame flexure. Other causes include loose or weak motorcycle to sidecar mountings and fittings.

After installing a sidecar, slightly tighten down the damper, if fitted. Or fit a hydraulic damper to assist controlling your outfit.

At the first sign of a wobble, grasp both handlebars very firmly. Never turn the handlebars loose. If tank-slapping wobbles persist the outfit is not manageable. Do not drive it.

## 3. HANDLING TACTICS

Make sure your tires have proper inflation. Check wheel alignment. Make sure the front tire and front wheel rim are balanced properly, running true (lateral) and circular.

Check the front wheel bearings. If loose, replace. Make sure the front tire wears evenly and is not chunked. Check front forks for correct alignment. The tele-fork seals and bushings must be in good shape. Check the front fork springs. Do not overlook steering head races. If all front end components are in good shape, go to the rear end. Be sure all suspension items, shocks, springs, and swing arm bushings are in good shape.

If all suspension equipment is okay, check all sidecar mountings carefully. There should be no movement at any connection at either end.

A damper applies a resistive force to damp out the wobble. Adjust a friction damper to provide enough resistive force to control the wobble while still allowing ease of steering. Some hydraulic dampers are adjustable; most are not.

Another way to reduce wobble is to increase trail. However, an increase in trail produces heavy steering. Yet another way to reduce wobble is to install a purpose built Earles type front fork. The Earles type forks are more rigid than telescopic front forks. The greater the rigidity, the less tendency to wobble.

A fork brace enhances rigidity of teleforks and reduces wobble.

## SIDECAR

### 3.5 Off-Road Riding

There are few places an outfit cannot go. No special skills are needed for off-road riding. The exception is negotiating deep rutted farm roads. If you have a Steib, Watsonian, or Harley-Davidson with low ground clearance, you may get "high-centered". You could knock a hole in your sidecar undercarriage. Stay out of ruts.

Your wheel track is narrower than "normal" wheel ruts for cars and trucks which adds to your discomfort. Do not try to straddle large objects between the sidecar wheel and the motorcycle. It does not work.

Special trials outfits are available for off-road racing with a high ground clearance below the sidecar body or frame. This increases the height of the center of gravity so they are not used on the street. Wasp specializes in Moto Cross machines.

The Wasp uses an Earles type front fork for front end rigidity.

Most off-road racing is done with a monkey in the sidecar. Unlike a passenger on a street rig, the monkey dives all round the bike and the sidecar. When turning to the right the monkey is hanging off the sidecar to the right; when turning to the left, the monkey has thrown his body over the rear of the bike behind the driver to keep the rear down. Only on the "straight" might he be found prone in the chair. Handling is very different.

## 3. HANDLING TACTICS

### 3.6 Trailers

A sidecar outfit is ideal for pulling a small trailer. The added pull on the outfit provides greater stability, especially on right-handers.

The tow ball on a solo machine mounts centrally and rear of the rear tire. This is not necessarily the best place for the tow ball on an outfit. The total width of the combination is one-half the width of the trailer to the left plus the sidecar to the right. This makes a very wide setup.

Another arrangement is for the right wheel of the trailer to fall behind the sidecar wheel. The left wheel of the trailer will then fall behind the cycle wheels. Typically, this places the tow ball on the inside sidecar frame member. For sidecars with an external frame, such as Watsonian or Steib this does not present a problem. The ball mounts on the inner frame member just in front of the rear frame member.

Install a fifth mounting member from in front of the ball hitch and extend it upward and forward to cycle main frame. This assists in distributing added loads from the trailer to the cycle frame.

The hitch location should allow full right- or left-hand lock turns without the trailer hitting the rear of the cycle or the rear of the sidecar. About one-half of sidecar outfits with tow balls have them in the same location as for a solo machine. The other half use an offset ball location.



## SIDECAR

### 3.7 Racing Sidecars

Racing a sidecar is not for the faint of heart. It is a very serious undertaking. Do not race on public streets.

Ali other racing vehicles have a single driver. A team drives the sidecar to victory, the driver AND his passenger. The word passenger is not correct as the passenger works as hard, or harder than the driver. You cannot talk over what you plan to do as you dive into a corner. You must feel what the other guy is doing, without even a glance at him. You correct for him and he for you.

A good passenger steers almost as much as the pilot. If the passenger is late in his actions the pilot must correct with his own weight and with the throttle.

These experts know the technique of steering with the gears and throttle. One dirt-track racing technique is to corner with the front brake on while under full power. Another is to scrub off speed by throwing the rig sideways and breaking the rear wheel loose. Don't attempt these while downtown on a street rig.

A heavy pilot needs a wider rig so his passenger does not work so hard to balance his weight. The wider rig makes it more difficult for him to be overtaken. On the other hand, he cannot take advantage of narrow slots that open up.

## 3. HANDLING TACTICS

### 3.7.1 Setting Up a Racing Rig

A 10 to 12 inch lead (sidecar wheel in front of rear wheel) is a good ball-park figure. Most use an inch of toe-in.

A trail of zero to one inch reduces the muscle work and provides quick, precise steering. A large trail will center nicely but requires considerable effort to steer. The reduced trail makes the rig easier to steer. A negative trail becomes very quick. Steering is self-energizing, requiring little driver effort. Steering effort saved is at the expense of self-centering. It is now difficult to steer straight. If the negative trail is not too great, some degree of self-centering still exists. This is partly due to the gyroscopic effect of the wheel. Another self-centering force is the pneumatic tire flexure which provides an inherent trail. Mike Parti used a 5/8 inch negative trail for racing on salt flats with no ill effects. This is not for normal racing and never for street use. The instability is violent at high negative trails.

Mike prefers a very steep head angle, as steep as 11 degrees. This keeps the rear wheel behind the front wheel preventing the rear wheel from driving around the front wheel. The steep steering keeps the front tire tread flat so you don't corner on the tire edge. You lose the unwanted "Wheelbarrow wheel effect."

The leading link forks are far superior than teleforks for many reasons. They are stronger, but

## SIDECAR

more important, they provide up to five times the lateral rigidity. The rigidity of the forks offsets wobble tendencies.

Another important feature is the front end rises under severe braking. With tele-forks the weight transfer causes the forks to compress and the outfit dives under severe braking. Weight transfer is not so much with link forks.

If you must use tele-forks, at least use a front fork brace so both sliders move up and down in unison. Large sidecar forces can weaken and break the front axle by loading it unevenly. The design of front axles was for solo loads only.

Rear wheels and swinging arms have very heavy loads thrown on them. The manufacturer intended his units for solo use only. To date, they appear adequate.

Straddle mounted sidecar wheels are much stronger than stub axles. Mike prefers the straddle mounted wheels. A stub axle, if used, must be very stout.

A sidecar brake helps in a road racing machine. They do not really help for normal track racing.

Mike removes carburetor idle stops. If he rolls the throttle off completely, the engine dies. This is much safer for everyone.

You do not chase after the damn outfit after it has bucked you into the ditch. Spectators do not need to dodge a riderless outfit. Best of all, the

## 3. HANDLING TACTICS

engine will self destruct by racing without a load.

Some general guides regarding proper weight distribution-

	<u>Front Wheel</u>	<u>Rear Wheel</u>	<u>Sidecar Wheel</u>
Dirt Track	45	35	20
Desert Riding	30	45	25
Road Racing	40	40	20

Above figures are in percent. Use a bathroom scale under each wheel to obtain the load on each wheel.

## 4. IMPROVING YOUR OUTFIT FOR BETTER HANDLING

A modern solo cycle needs several performance changes when set up for sidecar use. I will touch on a few points lightly, then some in greater depth.

For example: Most motorcycle wheels don't have strong enough spokes for the loads that a sidecar will impose. Use 8- gauge spokes in the rear wheel instead of 10- or 12- gauge spokes. The heavy spokes take much abuse when cornering. A set of 6/8 tapered spokes is even better. Buchanan can install tapered spokes.

Since the addition of a sidecar adds weight to the motorcycle, increase the spring rate by 20%. It is not as noticeable on the front of the motorcycle as it is on the rear. The rear is almost always in need of heavier springs.

General maintenance of cycle items is more important when a sidecar is attached. Set a time each day, week, or month for these chores. Your reward is a machine you can depend on.

Potential problem areas with a sidecar outfit-

- a. the swing arm bushings,
- b. front to rear tire alignment, and
- c. front end dampening;

## 4. IMPROVING YOUR OUTFIT

they can cause:

1. excessive low and high speed wobbles,
2. hard pulling during acceleration and braking, and
3. getting the rig to track straight.

These areas are problem making candidates. Check them as though they were important "modifications."

Most low speed wobbles are curable by the use of a steering damper. Many sidecar rigs have a slight to moderate slow speed wobble that some think is caused by the "toe in" of the sidecar wheel. Toe-in makes the rig track straight at average speeds.

The wobble usually occurs at 10 to 30 mph. Control the wobble by gentle acceleration while pushing forward on the bars. The wobble is minor with a properly set up rig.

Suggestions on tires varies with the intended use. Use a flat wide tread tire for dedicated sidecar operation. Stick with stock tire sizes unless you are certain a bigger tire will be better.

Knobbed treaded tires are the most versatile for most wet and dry weather and road conditions.

Sidecar rigs handle much better in snow than four wheelers when using a rear trials tire. Their

## SIDECAR OPERATOR MANUAL

traction and corner side slip is gradual which keeps hard right-handers from becoming potential trouble. Aside from their handling characteristics, they are cheaper than most of the other available tread patterns with comparable life.

### 4.1 Modification of a Modern Machine

As mentioned, the modern motorcycle is not well equipped for pulling a sidecar in stock condition. Doug Bingham, sidecar specialist on the West Coast, shows us the way. He wanted a machine to cover the 1500 mile Three Flags Run from Mexico through the United States and finishing in Canada. He chose a Honda 750 matched to a Watsonian Kennelworth Chassis. Now the modification began. Here is a list of what he felt was necessary-

Removed standard teleforks.

Fitted Earle's type leading link forks.

Installed a pair of Arnaco front shocks with 135 pound springs.

Replaced stock tires with 350-19 front and 450-18 rear trial pattern tires.

Added second disk to front wheel for improved braking.

Replaced stock 48t rear sprocket with 54t sprocket.

Added a pair of driving lights for better night driving.

### 4. IMPROVING YOUR OUTFIT

Added a windshield.

Added a travel trunk.

Added a travel-ease water seat.

Added Boge rear shocks with 159 pound springs.

Now the modifications to the sidecar-

Cut and widened the frame by four inches.

Used Girling automotive shock for third wheel.

Equipped third wheel with 520 x 10 tubeless tire.

Covered the wooden sidecar body with a thin layer of sheet metal bonded to the outside.

Covered front, rear and top with vinyl.

Fitted removable sun roof over each seat, two.

Fitted the windows with auto safety glass.

Made windows slide open.

Equipped windows with screens.

The seats could face each other, or face in the same direction, or to fold down into a 6' 2" bed.

Fitted an evaporative air conditioner. The 1.2 gallon tank and pump were hidden from view.

Fully carpeted the sidecar.

Covered the door and walls with wood paneling.

Installed: interior lights, blackout curtains, heater (for coffee) , cigarette lighter, and clock.

Also included- an FM radio, tape deck and CB radio for the rider and passenger, and a Bi-Com acoustical intercom system.

## SIDECAR OPERATOR MANUAL

The road performance is outstanding. The outfit rides like a baby buggy.

The results- The three country epic took 47 hours. Gas mileage was 30 mpg at 65 mph. To duplicate this machine in 1976 would cost about \$6000.

My own rig has the following modifications-

- \* Reduced trail by modifying the upper triple tree.
- \* Installed a front fork brace for stiffer fork legs.
- \* Installed an adjustable friction steering damper. Over the years I have tried different hydraulic dampers. I prefer the friction type.
- \* Increased rear end ratio by 12 percent.
- \* Replaced 18" spoked wheel in front with an 18" cast spoked wheel.
- \* Replaced 18" spoked wheel at rear with a 15" heavy cast spoked wheel.
- \* Replaced motorcycle rear tire with a steel belted auto tire.
- \* Used a five point mounting, no quick disconnect balls, instead of the conventional four point mounting.
- \* Replaced telescopic mounting struts for turn-buckle struts.
- \* Replaced the 350-10 trailer tire on the sidecar wheel with a steel belted 145-10 auto tire.
- \* Installed sidecar wheel brake with independent foot control, mechanical sls brake.

## 4. IMPROVING YOUR OUTFIT

- \* Installed trailer hitch on sidecar frame rail (inner).
- \* Installed additional lighting on cycle and sidecar.
- \* Fitted external crankshaft driven auto alternator.
- \* Replaced 32 A-H motorcycle battery with a 45 A-H auto battery.
- \* Replaced motorcycle electric horns with auto air horns.
- \* Replaced stock rear chain with extra heavy duty chain.
- \* Floated sidecar body off frame with coil springs.
- \* Controlled body damping with small gas shocks.
- \* Installed large camper-type rear mirrors.

I felt all these modifications to be important. Suspension was not changed as the stock suspension was extra firm. Each experienced sidecarist has done some of these modifications. Some have gone further.

You cannot stick a sidecar onto a motorcycle and expect it to perform as a sidecar unit. Your riding style may not require this full upgrade, especially if you divide time with your machine in solo trim and in sidecar trim. In this case, consider a solo machine and a sidecar outfit.

## SIDECAR OPERATOR MANUAL

You compromise sidecar performance if the rig is set for solo riding. You compromise solo riding if you set it as a sidecar rig and remove the sidecar.

All it takes to make a quality high speed touring sidecar is time and money. Perhaps the closest today is the EML custom outfits that sell for around \$14000. You may not really need all the modifications for your driving style. We will look at each change in component. You determine how far you wish to go to get this benefit.

### 4.2 Front End Geometry

Ali design criteria are compromises. You improve one aspect but from another.

One important measurement is rake angle, the angle the steering axis is forward from vertical.

Another measurement is trail. To determine trail-drop a line vertically from the wheel axle. Note where this touches the ground. Call this point "A." Draw a line through the steering axis until it touches the ground. Call this point "B." The distance between "A" and "B" is the trail. Trail will increase slightly if you extend the front axle.

Harley-Davidson reduced trail by keeping the same steering axis in the frame and pivoting the forks at the upper fork head. The forks slide back and forth at the lower fork head bracket. For reduced trail, move the forks forward. Harley no longer offers this option.

## 4. IMPROVING YOUR OUTFIT

Ali vehicles, whether they have two-, three-, or four-wheels, have some self centering action. A car uses a combination of kingpin inclination and caster. The greater the self centering action, the harder to start a front wheel wobble.

Self centering and tracking mean two different things. Self centering- if you turn the wheel then release it, the wheel will straighten of its own accord. A larger trail increases self centering. Larger self centering requires more effort to steer.

Tracking: the machine wants to continue straight ahead without wandering. The outfit will track without effort if one balances side forces. A slight sidecar wheel toe-in and a slight lean-out of the motorcycle should balance the side forces. A machine not set up correctly may straighten but not track correctly. A machine can also track correctly but be hard to steer.

All vehicles with a castor experience wheel wobble, including solo bikes and cars. It is just a matter of degree. Many newer, larger, and more powerful motorcycles increased trail for precision high speed stability. Leaning a single track machine into a turn requires little effort. You must steer a dual track rigid machine to turn. The large trail now makes steering very heavy. The muscle required comes from power steering in a car.

You supply the muscle with a sidecar outfit. The way to reduce steering effort is to reduce the trail. Some racing combinations use zero trail for very

## SIDECAR OPERATOR MANUAL

quick steering response. Reduction of trail also reduces self centering.

A trail of 1-3/4 inches to 2-1/2 inches is usually satisfactory for fast combinations. The high speed solo machine with a 4 to 5 inch trail produces heavy steering when fitted with a sidecar.

That outfit has a large resistance to wobble, providing other you fix all wobble inducing factors.

A smaller trail will not cause a wobble situation but it does reduce the self centering effect. As a result, use a damper which applies a resistive force to resist wobbles. Excessive damper forces increase steering effort and counteract self-centering.

A properly, set up sidecar should track straight without pulling to left or right. The sidecar wheel toe-in and cycle leanout offset the sidecar weight and drag. Zero toe-in causes a right drag correctable by pulling the left handlebar continuously. Quickly this becomes tiring.

You set your machine up in the garage. You obtained the toe-in and leanout under static conditions. At best, you loaded the outfit as you anticipated normal travelling conditions. You did not test under dynamic conditions while driving.

Any sidecar mount movement or frame flexure causes the sidecar to flex rearward or changes leanout. The dynamic trail and leanout change from the static values you carefully set up in the garage.

## 4. IMPROVING YOUR OUTFIT

The sidecar wheel may point straight ahead or toe-out under traffic conditions. It matters not you measured your toe-in when stationary. Always road test the outfit to determine final settings of toe-in and leanout. It must feel right.

Sidecar movement can increase a wobble, another reason for having a very rigid set up. Side loading also induces wobbles. Once I had a three point mounting with two upper mounts and a single lower mount. When the wobble developed, the sidecar frame visibly moved inward and outward in sympathy with the wobble. The three point mounting did not cause the wobble; lack of rigidity allowed the wobble to worsen. Fitting a fourth front lower rigid stabilizing link reduced the wobble.

An Earle's type leading link front end, if engineered properly, is more rigid than a telescopic front end. It has greater resistance to overcome the wobbles even with a smaller trail. Earle's type forks are on many racing outfits. Center hub steering offers more advantages but is expensive and complex.

Some modern cycles have only the wheel axle to prevent the tele-forks from twisting. Early machines had heavy bracing to support massive mud guards. Bracing the tele-forks between the lower sliders improves stability and reduces wobble.

Other sources of wobble include front wheel flexing caused by loose spokes or spokes that are too light. Check for play in the steering head or in the rear suspension swinging arm support.

## SIDECAR OPERATOR MANUAL

Check for an out-of-round front wheel or an out-of-balance front wheel. An outfit does not have to wobble. If you have an outfit that wobbles badly, determine the source of the wobble.

Installing a damper or increasing the damper force does not solve a bad wobble problem. It is like treating the cut on the finger of an accident victim dying of internal hemorrhage. This does not reduce the importance and necessity of a damper. A properly setup outfit has little need for a heavy damper.

My Laverda 3C had a large trail of 4.5 inches. This was reduced to 2.5 inches by modifying the upper triple tree. A heavy duty lower fork brace improved fork rigidity. A five point mounting firmly fixes the Watsonian chair. A very light friction damper cured the minor wobble present. When using a friction damper, adjust it to control head-shaking without increasing steering effort. Other outfits are not so fortunate. Japanese forks are less rigid as their fork tubes are of smaller diameter so expect more problems.

Heavier front fork oil assists in maintaining control on severe bumps. Slightly stiffer springs or a small shims provide additional pre-loading to prevent bottoming of the front forks.

## 4. IMPROVING YOUR OUTFIT

### 4.2.1 Leading Link Forks

A set of well designed leading link forks are more robust than telescopic forks. This rigidity is the major factor in reducing head-shaking tendencies. Another advantage of link-type front forks is their behavior under braking. A conventional telescopic fork extends while accelerating and closes during severe braking. The leading link fork tends to open under braking. This effect is opposed front weight transference caused by braking of the machine. The net results is little vertical movement during braking. Depending upon the front end geometry, the front may rise slightly, drop slightly or remain level under braking. This is better than the dramatic dip of conventional tele-forks. The link is more popular today for the serious sidecarist. It will not cure all problems but does eliminate many.

The trail required for a particular machine depends on whether the outfit fitted is a heavy three seater or a light single sports model. Reduce the trail a lot to make a heavy three seater sidecar steerable but install a damper. A lighter chair will not need as much trail reduction.

Several manufacturers offer leading link fork setups for sidecar outfits. The most popular are EML, Wasp, Unit, and Aerolink. Some come as a complete replacement front end with brakes, wheel, and tire. Others provide the forks only. One design offers an infinitely adjustable trail within certain limits, another has a solo trail and



## SIDECAR OPERATOR MANUAL

a sidecar trail. Some make no provision for trail changes. Leave fork changes to the experienced shop or mechanic. This is not a simple bolt-on exercise.

NOTE: Some racing outfits with link type forks use zero or a very small negative trail. They rely upon the dynamic pneumatic trail effect for a slight positive trail. This extremely small trail makes the outfit very susceptible to steering input. With little self-centering force, you turn the bars into the corner and turn them back to straighten. The machine will wander if you do not pay strict attention to your driving. Definitely not recommended for street use.

## 4. IMPROVING YOUR OUTFIT

### 4.3 Steering Dampers

Steering dampers provide a force to resist violent steering changes such as when a wobble occurs. Most early machines had steering dampers fitted. They are rarely found today. Sometimes you can adapt a model from an earlier machine to a later model.

One advantage of a friction damper is the ease of adjustment to fit the specific road conditions while driving. Just back off the adjustment when you remove the sidecar for solo use.

You can fit an hydraulic damper on any machine. An hydraulic damper works like a shock absorber. There is little resistance to movement as long as movement is slow and controlled. Should the movement be fast or erratic, the damper provides a large resistive force to overcome wobbles. Many find hydraulic dampers very effective. Some find the VW damper suits their needs.

Too much dampening and steering becomes dead and wooden. You actually increase steering effort. Steering is unresponsive and self-centering is lost. This can happen whether dampening is provided by friction or hydraulic damping.

Make sure the damper neither binds nor restricts suspension travel or handlebar movement. It should work on the steering head if possible. That is where the action is. The worst place is down near the wheel axle.

## 4.4 Suspension

A stock motorcycle suspension will not handle the additional weight and forces of a sidecar without protest. In addition to the added weight the suspension must now handle tremendous forces generated on cornering. With soft suspension you have excessive lean in the wrong direction when cornering. You cannot lean the outfit into a corner unless you have a lean control. The best is to corner with the outfit remaining nearly flat. The weaker the suspension the more the sidecar will lift when turning right. It will also cause the cycle to lift when turning left.

Install the stiffest suspension you can tolerate at the front, rear, and sidecar which absorbs road jarring without allowing the outfit to wallow. The softer the suspension the less the performance. Everything is a trade.

For increased sidecar passenger comfort, float the sidecar body (or seat) from the sidecar frame. The Watsonian body is easily sprung and damped. Retain the front pivots and support the rear by two coil springs. Control movement with mini shock absorbers used to control auto engine torque.

Give attention to all suspension systems (front, rear and sidecar) for best results. Lateral stabilizers or an anti-sway bar is another way to improve handling. MZ uses this to advantage. Softer suspension is possible when you use a sway bar.

## 4. IMPROVING YOUR OUTFIT

### 4.5 Gearing

The solo gearing is for solo riding. When you add a sidecar your added load strains the clutch, transmission, shaft drive, chains, and engine. You will stall easier. Acceleration will not be as brisk. You will spend more time in the lower gears. Your solution is to increase gearing and increase engine speed for the same road speed. This is not always easy.

Typically, an increase of 10 to 15 percent is good for larger displacement machines but small displacement machines require an increase of 20 or 25 percent. You may reduce the primary sprocket by one or two teeth or increase the secondary sprocket on the rear wheel by two to five teeth, or some combination of the two.

Shaft drive vehicles such a BMW or Honda Gold Wing, may require a new rear end which is difficult and expensive. Another method to increase gearing is use a small rear wheel which accepts an auto steel belt radial tire. The 15 inch is most popular but the 13 inch is sometimes used. This will give a 9 to 12 percent increase which is ideal. **WARNING** - Do not fit fat auto tires to skinny motorcycle rims. The bead can slip off and the tire may explode. Use only auto rims for auto tires. With increased gearing you no longer lug the engine. You will not stall on takeoff. Your acceleration is brisker. You stay in taller gears longer. And your top speed is better.

## 4.6 Chains

Many motorcyclists ignore chains then complain at the resultant short life. A chain is a precision piece of machinery. Treat it as such. There are over six hundred separate precision working parts in a typical chain. If you insist on jack rabbit starts and do not take care of [our chain, it will repay you with a very poor life. If you drive in a sensible manner and regularly take care of your chain, it will give long and dependable service.

Because of the added load you must provide more frequent service intervals. Servicing intervals of 500 miles or so might be okay for solo usage, but reduce these to 200 or 250 miles for sidecar operation. Observe the following guides-

- 1) NEVER have the chain too tight. The chain will heat up. You will strain wheel bearings and counter-shaft bearings. Always follow the recommendations from your manufacturer.
- 2) NEVER have a loose chain. A loose chain can jump off a sprocket with little difficulty. It is noisy and easily snagged. It adds nothing to your enjoyment. Always keep the chain within normal limits.
- 3) ALWAYS be sure the rear sprocket is parallel to the counter-shaft sprocket. Be sure both sprockets are directly in line. Replace worn sprockets promptly. Worn sprockets accelerate chain wear. Offset minor sprocket wear by reversing the sprocket if possible.

## 4. IMPROVING YOUR OUTFIT

- 4) DO NOT field dress sprockets. Leave rebuilding, if required, to the specialists.
- 5) APPLY lubricant to all types of chains. Self-lubricating chains benefit b[ regular cleaning and tensioning. Any neglected chain is a ruined chain.

There are two ways to lubricate a chain. One is to remove the chain, then thoroughly wash in kerosene (not gasoline). Place the chain in a special purpose solid grease (such as Duckam's Chain Grease) and heat until the grease is liquid. Remove pan from heat and allow to cool until grease begins to stiffen. The chain is removed and hun~ up to cool. Wipe off excess grease and replace chain.

A spare chain, threaded to the existing chain, will ease removal and replacement. Lube a spare so it is ready to install whenever the chain in use requires attention.

Service an endless chain by removing a link and installing a master link. Always adjust chain tension and check wheel alignment whenever you remove or replace a chain. You do this servlce less frequently than if you just sprayed the chain with a liquid or solid lubricant.

The other method is to regularly spray with a special purpose chain lubricant while the chain remains on the machine.

## SIDECAR OPERATOR MANUAL

The following tips aid better lubrication:

- a) Remove mud or dirt if necessary. Use kerosene only.
- b) Apply lubricant to a just warm chain. Chain is warmed after a 50 to 100 mile trip.
- c) Rotate wheel while applying lubricant on inside of chain between side-plates and links. Be sure both sides are treated. Rotate wheel slowly.
- d) Check chain adjustment and wheel alignment. Adjust if necessary. Perform this service more often than the removal of chain type service.

OTHER factors to watch are: Chain wear must be uniform. Replace a chain with a "tight" spot.

Replace a chain when uniform wear exceeds 3 percent. Replace a noisy chain.

Carry a spare master link always. Make the master clip secure using a thin flat flexible metal strip. The closed end of the clip always faces the direction of travel of the chain.

The chain operates in a hostile environment. An equivalent chain used in an industrial application for the same loads and speeds is lighter and multiplexed. It would have continuous forced lubrication. It would be totally enclosed. It would last 100,000 hours. Keep this in mind when you consider neglecting your chain.

You can upgrade your chain for better life. Use a higher strength chain. The strength of a 3/8 x 5/

## 4. IMPROVING YOUR OUTFIT

8 chain is from 3500 pounds up to 9500 pounds for a supreme racing chain. Use the best chain your pocket book will allow and treat it with care.

Replace the chain and sprockets to accommodate the next larger chain. This is good if you plan to drive slowly while pulling very large loads. The heavier chain (No. 630 versus No. 530, for example), generates higher centrifugal loading forces. Very heavy chains can self destruct at high speeds. The heavier chain has fewer teeth on the counter-shaft sprocket. This may not be desirable for good power transmission.

Some have replaced the chain and sprockets with a duplex chain and matching sprockets. Chain life of 50,000 to 80,000 miles is possible with rear duplex chain systems. Most machines cannot accept a duplex chain because of severe space requirements. Little space exists between the chain and frame members, and between the chain and wheel hub, and between the chain and the transmission housing).

A heavy O-ring chain from a reputable manufacturer is a good choice.

## 4.7 Wheels

Like everything else about a combo, the wheels take more punishment than the wheels on a solo. The sidecar wheel is often slammed into sidewalk curbs. Some drive an outfit recklessly over rocky terrain where few soloists dare to go. The adventuresome sidecarist has little fear of potholes. This punishment takes its toll on all rolling components.

A steel rim is easily hammered out to remove small or even larger dents but a bent alloy rim is straightened with difficulty, if at all.

On the other hand, substantial seven-spoke alloy wheel will withstand much larger continual side forces than a conventional spoke wheel. Spokes break at the last engaged thread in the nipple, or where the spoke fits into the hub. Spoked wheels are for solo operation, not hauling a sidecar with Mama, dogs, kids, picnic basket and tent.

Some wheels are less prone to spoke breakage than others. The BMW has straight pull spokes where the spokes fit into the hub. A better concept is hard to imagine. Sometimes you can cross-lace spokes more effectively where the spoke has a right-angle head. Leave this to the experts such as Buchannan's Wheel Shop.

If spoke breakage is common for your wheel, do not despair. Spokes are available in a wide variety of forms and materials. Cure head breakage with a 10g step spoke. The 10g nipple and major

## 4. IMPROVING YOUR OUTFIT

spoke length is stepped to 8g before the curve and hub end. If breakage is at the nipple end, use a larger diameter spoke. The larger spokes require enlargement of spoke holes.

Before respoking your wheel, be sure you have a problem first. Neglect is the prime culprit. With time and wear, some spokes elongate slightly or become loose. If this continues, the loose spoke will not break. It is not taking its share of the load. The over-tensioned spokes surrounding it will. Always check your spokes for tension regularly by feel or by plucking. A correctly tensioned spoke will have a characteristic sound. Tighten any loose spokes very carefully until they "feel" right. Tighten a little at a time and do not cause the rim to warp or egg, or you will be in deep trouble. Remove the tire and wheel first before doing any spoke tightening.

Spoke all wheels for heavy duty sidecar use. Maintain them properly. They will give years of trouble free service.

A word of caution- Unless you are very mechanically skilled, do not attempt to rebuild your own wheel. You may have an awful mess. Leave rebuilding to professionals such as Buchanan's on the West Coast.

Wheel bearings are also important. A solo machine has little horizontal stress on the wheels so ball-bearing races or roller bearings suffice. These bearings do not withstand severe side

loads. The best replacement bearings for sidecar service is a set of adjustable conical roller bearings. Many sidecar wheels use tapered roller bearings. They last almost forever with periodic maintenance, a shot of grease now and then.

## 4. IMPROVING YOUR OUTFIT

### 4.8 Tires

Tires on an outfit will last nearly as long as they would on a solo if properly aligned, if driven in a prudent manner, and if using sidecar designed tires. A solo machine requires different tire characteristics for the front wheel and for the rear wheel.

A sidecar outfit has tire requirements similar to a car. Major differences in tire characteristics between the front and rear tire are absent.

Some outfits (the newer Harley-Davidsons, the Ural, some BMW's and some early English models), have interchangeable wheel. They will fit on front, rear, or the sidecar. A wrap around tread profile, required for solo cornering, is now detrimental. The outfit is always vertical, or it should be, so you want a flat profile tread like the Avon Triple Duty MK II, or better still, an auto radial tire. A Dunlop Universal Trials tire gives good service. With a Motocross type tread on the rear, there are few places you cannot take an outfit.

You will get very rapid tire wear if sidecar alignment is incorrect. Other factors include wheel misalignment, buckled wheels, grabby brakes, and by poor suspension. Do not overlook wheel imbalance from heavy spots or security bolts.

Another cause of rapid tire wear is over inflation. This distorts the tire and results in rapid center tread wear. Too little inflation also places undue strain on the casing, absorbs power and results

## SIDECAR OPERATOR MANUAL

in rapid edge wear. High speed increases tire wear because of the higher temperature. Quick braking and harsh acceleration eat tires.

Expect more tire wear in summer than in winter because of the higher temperature road surface. Tread rubber absorbs grease and oil. Unless cleaned off quickly, the casing will deteriorate. You get more tire wear driving on abrasive road surfaces.

Overloading is another cause of rapid tire failure. Check tire pressures weekly and adjust to the correct pressure. This should be the pressure for the maximum load rating of the tire, unless the rim has a lower pressure rating. In this case do not exceed the pressure rating of the rim. Remove stones and other objects regularly. Remove any oil or grease. Reverse the front tire if you notice uneven wear. Check wheels for proper balance, true running, and roundness.

The now generation of sidecar outfits such as the EML and the HMO have narrow steel belt auto tires, the ultimate in sidecar tire design. This drops the center of gravity of the outfit for greater stability. The increased gearing is optimum for performance. The auto tires permit a higher maximum allowable loading. The flexible sidewalls keep the tread in contact with the road. The flat tread profile provides maximum traction. The hard tire compound gives longer life. Operating temperatures are lower.

## 4. IMPROVING YOUR OUTFIT

The reasons why this type of auto tires are so successful when fitted to all wheels of a sidecar outfit are outlined below.

A decade or so ago the motorcycle tire had a flat or near flat tread profile. Motorcycles with sidecars were fairly common.

Motorcycle manufacturers often provided sidecar mounts built in their frames. Sidecar popularity waned and so did the built-in sidecar mounts. Motorcycles became more powerful. Tire manufacturers quickly developed tires suitable for high speed solo operation. They also forgot the small but dedicated market of sidecar enthusiasts.

The motorcycle tire now embodied features for high speed cornering such as a round or Vee profile and stiff sidewalls. This allowed the solo to lean at extreme angles and still keep some tread on the ground. The fine tuned motorcycle tire is no longer suitable for serious sidecar use.

A sidecar outfit needs flexible sidewalls and a flat profile such as found on tires for auto service. Most auto tires are too fat.

Only those made for the Citroen 2CV and other small cars has suitable dimensions. That size is readily available in Europe.

Soon several sidecar manufacturers used those auto tires on high performance sidecar outfits. The wheels fitted motorcycles but the rims took the auto tires.

## SIDECAR OPERATOR MANUAL

Every characteristic built into the super motorcycle tire was of wrong for sidecar application. This even applies to the ultra new radial motorcycle tires. Radial motorcycle tires are unlike auto radial tires. The sidewalls are much too stiff. The suspension on a super bike is relatively soft so the stiff sidewalls are fine. Taut suspension and a good handling sidecar outfit go hand in glove. Road shock travels through the stiff sidewall and into the sidecar outfit. Motorcycle radials are not for sidecar outfits.

The optimum sidecar outfit tire has the following specifications-

- \* The tread is flat over the major width of the tire.
- \* The tread pattern is deep and designed to prevent aquaplaning.
- \* The tread compound is tough to enhance tread life. The tough tread allows the rig to slide in a controlled fashion.
- \* The tire is designed for maximum loading, not high speed.
- \* The tire sheds excess heat buildup.
- \* The sidewalls are flexible to keep the tread on the ground when cornering. The flexible sidewalls absorb road shock.
- \* The tire width is small to fit between the arms of the rear suspension.
- \* The rolling circumference is about 10 to 12 percent smaller than the equivalent solo tire.

## 4. IMPROVING YOUR OUTFIT

This compensates for the added weight of the sidecar and restores performance. (It is almost impossible to inexpensively increase gearing of a shaft-driven motorcycle). Use of this tire also lowers the center of gravity of the rig a little.

Will this require a special tire design? No. Such tires already exist and used daily on the European sidecar outfits such as the EML and the HMO. You can retrofit them to your machine.

A word of caution. Once you make this change you can no longer use your motorcycle as a solo. It is for the dedicated sidecarist only. If you want to enjoy the best of both worlds, consider a sidecar outfit AND a solo machine.

Another word of caution. Do not obtain your tires from an auto supply dealer. The tires he normally carries in stock are the fat auto radials. They are unsuitable and may explode while installing if fitted to a skinny motorcycle rim. Use only narrow auto radial tires which found in specialty tire outlets. Get them also from importers of the EML outfits, from the Citroen agent, and from the Michelin warehouses.

Check that the rim is suitable for the tire. While the motorcycle rim and the auto rim share the same nominal size they have different physical dimensions in critical places. The motorcycle rim is deliberately a bit larger in OD than is the auto rim. If you want to fit an auto tire to a motorcycle, be sure you have also installed an auto rim,



or have turned down the rim of the motorcycle rim to that of the auto rim. Once you have done that, you can never fit a motorcycle tire to that rim. Several have fitted auto tires to motorcycle rims and have gotten away with it, other have tried to do the same and the tire has exploded during fitment. Some have gotten seriously injured fitting auto tires to motorcycle rime. Others have gotten killed fitting tires, period.

The early motorcycle tires built for sidecar use are also not suitable for the modern high speed touring machine. They were fine when the motorcycle weighed between 300 to 450 pounds and had only 35 to 45 hp on tap. The modern tourer weighs between 650 and 850 pounds and has 65 to 95 hp on tap. The old tire designs are just not adequate. You will overload them quickly. Expect excessive heat bulldup and rapid tire wear. They also are not suitable. Nor are the old auto tires and for the same reasons.

## 5. SIDECAR DESIGN THEORY

### 5.1 Adjustable Sidecar Trim Systems

A sidecar pilot learns, when setting up his outfit, that motorcycle leanout is a powerful tool to control steering. Most outfits give neutral steering with 5/8 inch (+/- 1/4") leanout at the handlebar. The outfit should steer straight ahead with little pull in either direction, if not subject to head or side winds, heavy loads, or steep road crowns.

These factors can and do change. A strong head wind applies force on the sidecar body and windshield. You fight this force to the right by turning the handlebar slightly to the left. Your steering input overcomes changes in road crown or passenger loading. You keep your rlg pointing straight ahead by your constant steering input.

If motorcycles had gearboxes in the steering head like automobiles, these forces would be controllable. You can even feel yawing forces in your automobile. If we reduced front wheel trail to zero then the castoring effect, turning forces, and self-centering would all disappear. You could never let go of the handlebars while underway. Flat land sidehackers reduce front wheel trail to 2 inches, about one-half the normal trail. The old BMW "Earles" leading link fork allowed sidecar use by having a forward set of pivot lugs for this purpose. It would be nice to be able to set the bike back for solo riding conditions on occasion.

## 5. SIDECAR DESIGN

A better solution is a system to allow the bike to lean independently of the sidecar. Flxi developed this in 1910 using a parallelogram type frame which made the sidecar wheel lean parallel to the motorcycle. Recent flexible outfits have simple pivots near the centerline of the motorcycle. Several "flexible" mounts to allow the cycle to lean. The sidecar looks like a single wheel trailer.

All flexible designs work fairly well in normal use, but all share potentially hazardous characteristics. The outfit steers like a solo machine by leaning the motorcycle into a turn to counteract centrifugal force. If the connecting links do not allow enough lean, or if the cycle comes up against the sidecar, you can lose control. If the outfit drifts in a slick corner, nothing prevents the cycle from flopping over. Flexible outfits are not practical on slick surfaces such as ice or snow.

A safer system to control leanout provides a dynamic leanout adjustment locking the system solid when not changed. Adjustment system includes electrical or mechanical jackscrews, hydraulics, and torsion bars.

A jackscrew is a coarse threaded rod like in a bench vise or C clamp. Most aircraft use jackscrews to control landing flaps. They are strong and reliable. Screwing the rod in or out leans the motorcycle in or out. Jackscrew leanout systems use a three point mounting, where the jackscrew is the upper mount.

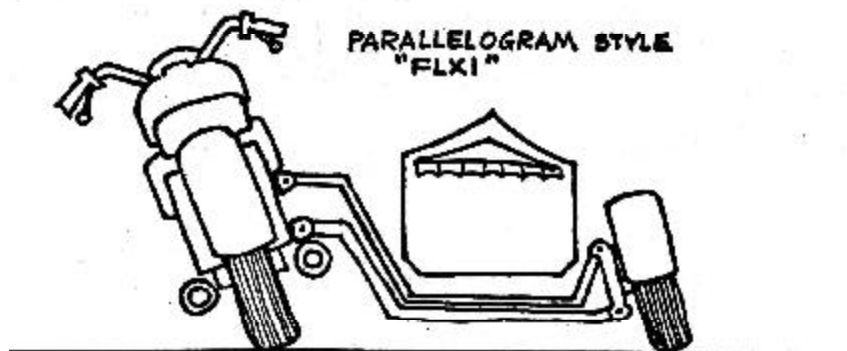
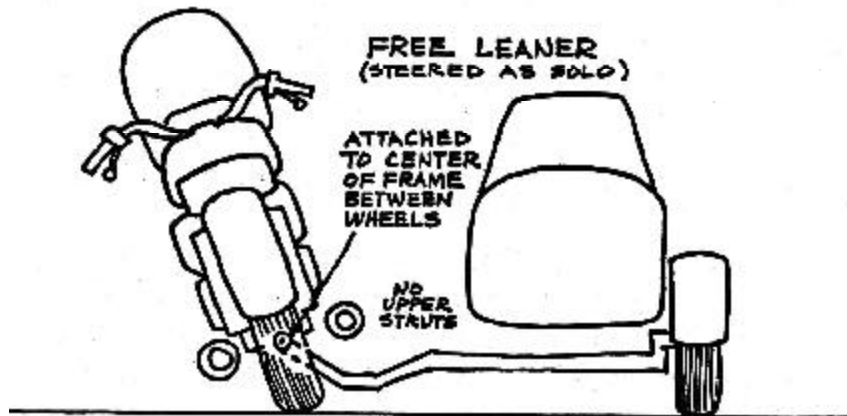
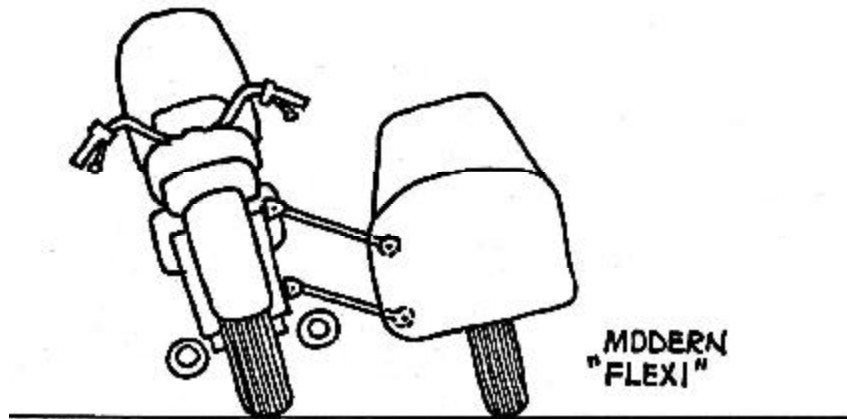

## 5. SIDECAR DESIGN

Vetter used a mechanical jackscrew adjustment. Goodwin used an electric motor to power the jackscrew. The electric motor can change the attitude of the motorcycle by 15 degrees in 3 seconds. This feature allows you to change direction quickly. You lean the cycle into the curve as you approach the curve, not when you are in the curve.

David Hough developed a prototype hydraulic system which was proved very reliable. It is costly and complex. Too sophisticated for the intended market. David has the bits and pieces and some sources. Motovation's system uses an adjustable torsion bar which raises or lowers the sidecar suspension. Use it to correct for load changes, a change in road camber, or a change in wind direction. It provides no assistance for cornering.

The passenger provided the lean control required in those controlled leanable racing sidecar outfits of the early fifties. Competitive they were, but banned after several spectacular accidents.

## 5.2 Front End Geometry (Theory)

A sidecar outfit looks like a motorcycle but has some handling characteristics of a four wheeler. This complex vehicle compares to neither. We must explore the characteristics of both before addressing the outfit.

### 5.2.1 Comparison with a Motorcycle

Any steered rolling wheel whose contact patch with the ground lies behind the intersection of the steering axis with the ground is a castor. All castors wobble. You can control most castor wobbles.

The trailing patch gives low speed directional stability. It also causes a sinuous steered path in some speed ranges (wobble, shimmy, or shake).

A motorcycle is actually two castors coupled at the steering head. The first castor (front wheel) induces the low speed steering wobble, normally between 6 to 8 Hz (cycles per second). This typically occurs between 15 to 35 mph. The second castor (rear wheel) has its tire contact patch behind the intersection of the line from the steering head and the ground. This induces a high speed weave of the entire machine at 2 to 3 Hz. If it occurs it will normally be at speeds over 80 mph.

The above analysis does not consider a sidecar. Addition of a sidecar does not create a wobble situation. It only amplifies the low speed wobble or modifies the high speed weave of the motorcy-

## 5. SIDECAR DESIGN

cle. The low speed wobble and related steering problems are more important than the high speed weave as applied to sidecar outfits.

The steering head falls when you turn the front wheel and tries to cause the wheel to turn further. Note the word "tries." I did not say it causes the wheel to turn but TRIES to cause the wheel to turn. The difference is very important. Other effects will try to cause the wheel to return to the straight ahead position.

For relatively small trails and relatively small front wheel loadings the effect is very small. Such is not the case when the trail is large or if load on the front wheel is high.

For a given lateral stability a larger trail results in higher stability and a lesser tendency to wobble. Any side loading, such as the addition of a sidecar, or cornering on a solo can induce a wobble. An increase in trail to obtain better stability results in heavier steering.

A motorcycle equipped with a sidecar has two factors working against it. The weight of the sidecar adds to the heaviness of the steering and the side loading can induce a wobble. Other causes of wobble include loose bearings (wheel or steering head), rear swing bushings, flimsy mounts, weak or loose spokes, out of round or out of balance tires and wheels. A solo machine shares many of the causes of wobble seen in an outfit. They are amplified by the side forces of the sidecar.

## SIDECAR OPERATOR MANUAL

G.G Roe of the University of Manchester, with W.M. Pickering and A. Zinober of the University of Sheffield developed computer models of solo motorcycle oscillations. These studies showed a more rigid front suspension solved the wobble problem.

Telescopic forks are relatively flimsy. Link type forks are up to five times stiffer (as far as lateral rigidity is concerned). This fork proved itself in road tests and in racing machines. By increasing wobble resistance you can reduce the trail to lower values than possible with teleforks and not suffer low speed wobbles. The lower trail requires less driver input and thus easier steering.

### 5.2.2 Comparison with a Car

The ability of a car to proceed straight ahead (self centering) is the result of two forces. You get some degree of self centering by using the castor effect as in a motorcycle. A positive castor means the steering axis is tilted backward at the top. The angle is not as important as the distance between the center of the tire contact patch and the intersection of the line through the steering axis to the ground. Positive trail returns the car to the straight ahead position after a turn. It also exerts a force to keep the car moving in a straight line.

Even with a zero castor angle a dynamic positive trail exists due to flexure of the tire casing itself. With positive trail, if the wheel is turned, side scrubbing forces try to straighten the wheel.

## 5. SIDECAR DESIGN

Self energizing steering uses a negative castor. Once the wheel is turned slightly, the same forces try to make the wheel turn even more. On the other hand, the vehicle is very unstable. Slow and easily controllable heavy vehicles use negative castors. A small negative castor which, combined with pneumatic trail, still gives a slight positive trail while in motion. Chrysler uses  $-0.50 \pm 0.50$  degrees for their manual steering vehicles. They use  $+0.750 \pm 0.50$  degrees for vehicles with power steering (1967 specifications). For racing (auto) applications, the lighter the front end, the more positive the castor permissible.

The other force controlling straight line stability is the lateral angle of the axis of inclination. As you turn the wheel the vehicle lifts slightly. The steering spindle moves downward, turning about its own inwardly inclined axis. This adds to straight line stability because the weight of the vehicle works against turning the wheels from the straight ahead position. This further increases steering effort.

Steering axis inclination is not usually adjustable. It is often ignored in describing vehicular motion. Some racing outfits use a spindle axle for the motorcycle front wheel with excellent results. Center hub steering reduces the center of gravity and allows for a very rigid front end. (Reference- "A Chassis " by W L Harvey and D B Ressler, Jr.) Adjustment Analysis, ....

## 5.3 Stability Analysis while Turning

When driven too tightly into a corner a vehicle either skids or overturns. Whether it skids or overturns depends on many factors. These factors include- the configuration of the vehicle, the height of the center of gravity, the approach velocity, the radius of curvature, how and when power is applied, and the grip the tires have at the road surface.

Centrifugal force which acts in a direction away from the center of turning and through the center of gravity of the vehicle. The C of G is fairly close to the motorcycle but towards the sidecar.

It is fairly high, and towards the rear. The location of the C of G depends how you load the outfit, whether you place the passenger on the pillion or in the sidecar.

When turning away from the sidecar the roll-over axis lies between the front wheel and the sidecar wheel. When turning towards the sidecar the roll-over axis is between the front and rear wheels of the motorcycle. This distinguishes a sidecar outfit from all other vehicles, including other three wheel vehicles.

All it shares with a solo motorcycle is its appearance, then only if you look at it from the side of the motorcycle. It still resembles a motorcycle. If you drive it as a solo motorcycle you come to grief quickly. You go left if you counter-steer left to go right.

## 5. SIDECAR DESIGN

This section describes the basic forces generated when turning right or left with a motorcycle and sidecar. It does not take into account factors such as slip, drag, acceleration forces, or change in the center of gravity due to body English. These factors change the analysis somewhat.

### 5.3.1 Right Hand Turns

Consider the over-turning force present during right-hand turns. Many motorcycle riders think centrifugal force for a motorcycle with a sidecar is not problem. When told it is, they believe the left-hand turn, not the right-hand turn, is more difficult because of centrifugal force. Wrong.

We lean a bike toward the inside of a turn to balance the centrifugal force generated during cornering. The center of gravity (C of G) of the bike plus rider moves to the inside of the turn. We lean the bike until the resultant horizontal force of the bike and rider's weight and the horizontal centrifugal force balance. We then turn safely and confidently. Tire adhesion resists the horizontal force and prevents side slip.

Turning a solo motorcycle without leaning to the inside of the curve is unthinkable, unnatural and unsafe. With a sidecar attached, you must turn to right or left without leaning. The rigid attachment makes it impossible to lean. It is a two track rigid vehicle.

## SIDECAR OPERATOR MANUAL

Turning a sidecar left is not usually a problem. The outrigger sidecar and sidecar wheel stabilizes the outfit. In the same way, an outrigger keeps a Polynesian type sailing craft from capsizing in a strong wind.

Caution- too strong a wind or sudden gust will capsize even an outrigger boat. Likewise, too fast a left-hand turn can cause the sidecar rig to flip tail-over-sidecar to the right. This will not occur unless you turn too fast at too high a speed, or brake hard with the front brake after entering the turn.

You generate centrifugal force when you turn. From high school science and physics courses-

$$F = M \cdot a \quad (1)$$

or, the force, F, equals the mass of a body, M, times its acceleration, a.

For circular motion, such as a motorcycle or motorcycle/sidecar combination turning, this formula becomes-

$$F = M(v.v)/r, \text{ or } F = (W/g) (v.v)/r \quad (2)$$

where: F = centrifugal force (lb)

W = total weight of bike, rider, sidecar and passenger (lb)

g = acceleration of gravity (32.2 ft/sec/sec)

v = velocity of bike (ft/sec)

r = radius of turn (ft)

M = mass (poundals)

## 5. SIDECAR DESIGN

Applying this equation to a typical motorcycle/sidecar rig-

Weight of bike = 400 lbs

Weight of rider = 175 lbs

Weight of sidecar without passenger = 100 lbs

Total weight of rig (W) = 675 lbs

Velocity (v) = 30 mph = 44 ft/sec

Radius of turn (r) = 50 ft

The centrifugal force is-

$$\begin{aligned} F &= (675/32.2) \times (44 \times 44)/50 \\ &= 675 \times 1936 = 812 \text{ lbs} \end{aligned}$$

This is a whole lot of pounds to have pushing sideways on your bike and sidecar rig. It just might be too much. How can we know? In this case the sideways force due to centrifugal force is equivalent to 1.2 g. Unless the tires grip like glue and the chair does not fly it is probably too much.

One way to find out is by experience. Experience can be expensive and dangerous. We can experiment carefully by starting out easy and feeling our way gradually into faster and tighter turns. Or we can study the basics from a theoretical standpoint.

## SIDECAR OPERATOR MANUAL

First we determine where the location of the center of gravity of our total rig. (Refer to Figure 1)

The force due to weight,  $W$ , acts vertically downward through the center of gravity. The centrifugal force,  $F$ , acts horizontally through the same point. Note that  $W$  acts at distance  $A$  from the

point,  $O$ , located on a line between the point of contact between the front and rear wheel. The force,  $F$ , acts a distance,  $H$ , from the same point,  $O$ .

The product of a force and its distance from the point where it acts is called a moment. There are two moments acting - the weight moment holding the sidecar rig down onto its wheels; and the centrifugal force moment which tries to lift the rig off the ground.

To make a turn safely, we must use a speed and turning radius that keeps the centrifugal force moment less than the weight moment.

This relationship is shown below:

Use the equation for equilibrium by taking moments about the point of contact,  $C$ -

$$W.A = F.B \quad (3)$$

For right-hand stability, this means that •

$W.A$  must be greater than  $F.B$

The sidecar wheel will remain on the ground in a right-hand turn if and only if the weight moment is greater than the centrifugal force moment.

## 5. SIDECAR DESIGN

The sidecar will lift if -  $W.A$  is less than  $F.B$ , or the weight moment is less than the centrifugal moment.

The center of gravity lies between the bike and the sidecar and at a height above the ground of about 15" to 20" For this exercise we assume it is 15" above the ground and 6" to the right of the bike centerline.

Using the factors of Equation 3, the values in our example give-

$$W.A = 675 \times 6 = 4,050 \text{ in-lb}$$

$$F.B = 816 \times 15 = 12,300 \text{ in-lb}$$

As  $F.B$  is much greater than  $W.A$  the rig is very unsafe.

The 50 ft radius curve is unsafe at speeds over 25 fps or 17 mph. That curve had a posted speed of 15 mph. The road designers probably knew what they were doing.

NOTE- As explained elsewhere, the greater the stability factor, the faster a particular curve can be taken. No vertical force is on the sidecar wheel when the centrifugal moment balances the restoring weight moment.

You can find the ratio of these moments by a simple static test. With the outfit loaded normally for driving, pick up the sidecar until the outfit is just balanced on the cycle wheels. Drop a plumb bob from center of bottom of tire to ground. Measure the height. Measure from this ground point,



## SIDECAR OPERATOR MANUAL

the right angle distance to the line between front and rear wheels.

Determine Stability Factor, S.

Enter above graph to determine maximum safe speed for any radius of curvature, This is the speed where road contact is lost at the sidecar wheel.

Advanced techniques allow a higher turn speed than the theoretical speed given above. These techniques include touching the front wheel brake lightly while accelerating. Not for beginners.

As  $F \cdot B$  is much greater than  $W \cdot A$  we have an unstable or an overturning condition. The sidecar wheel would lift way up and we would upset to the left. In attempting to correct we may steer left, possibly into oncoming traffic. We may cross the road, or even go off the road.

How do we prevent this? The centrifugal force varies with the outfit weight, with the velocity squared, and inversely with turn radius. Velocity has the most pronounced effect (because of the squared function). Centrifugal force increases four times if we double our speed. The tightness of the turn contributes in a direct proportion. If the turning radius is cut in half, the centrifugal force generated doubles.

From Equation 3 we obtain two useful ratios-

$$F/W = A/B \quad (4)$$

Translating this-

## 5. SIDECAR DESIGN

At equilibrium, the ratio of the centrifugal force,  $F$ , to the total weight of the bike, rider and sidecar,  $W$ , equals the ratio of the distance of the rig's C of G from the bike center line to the distance of the C of G above the ground. Refer to Figure 1.

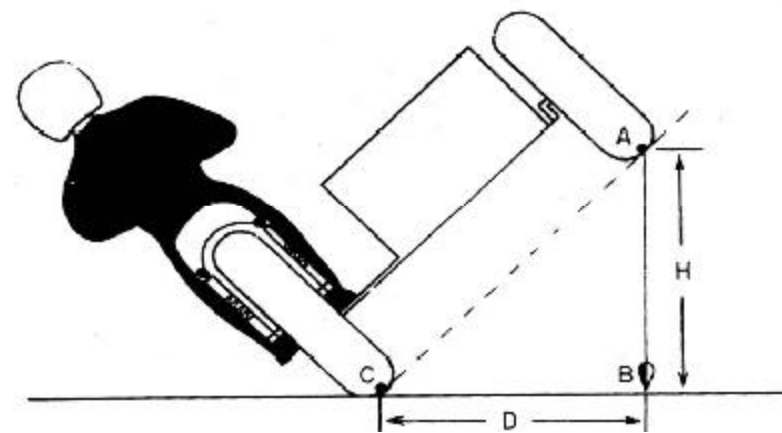
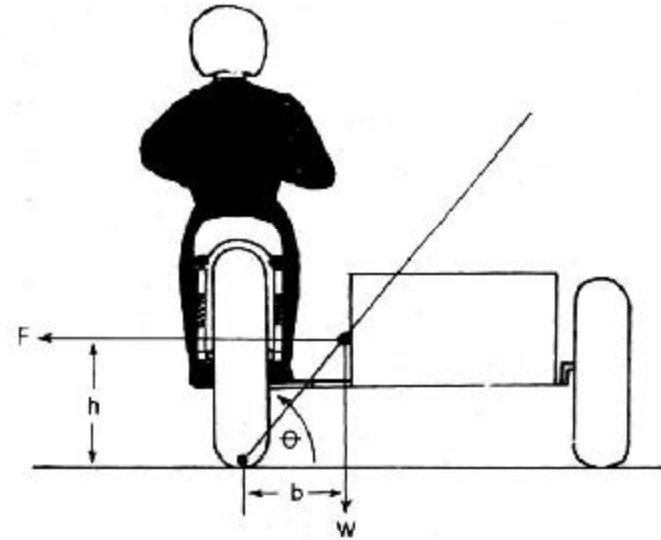

Figure 1 - Stability Determination

## SIDECAR OPERATOR MANUAL

Equation 4 and the ratio of A with respect to B is very meaningful. The larger this number the greater the right-hand stability of the rig.

Solving for centrifugal force, F, in Equation 4-

$$F = (A/B) \times W$$

Substituting this into Equation 2 gives a new relationship for centrifugal force-

$$F = (W/g) (v.v)/r = (A/B) W \quad (5)$$

Solving for v gives-  $v.v = (A/B) r.g$

$$v = \sqrt{(A/B)r.g} = 5.66/\sqrt{(A/B) r} \quad (6)$$

The 5.66 makes the units come out correctly.

This equation gives the safe limit velocity, v, for a motorcycle-sidecar rig of given (A/B) ratio taking a corner of radius, r. With any two factors known, you can calculate the third.

The velocity, v, varies with the square root of the (A/B) value and the square root of the turning radius, r. The (A/B) ratio determines the performance of a sidecar rig, the relative performance of different rigs, or changes to a rig.

Larger (A/B) values increase stability in a right turn. Consider the four examples in Table 1. over.

## 5. SIDECAR DESIGN

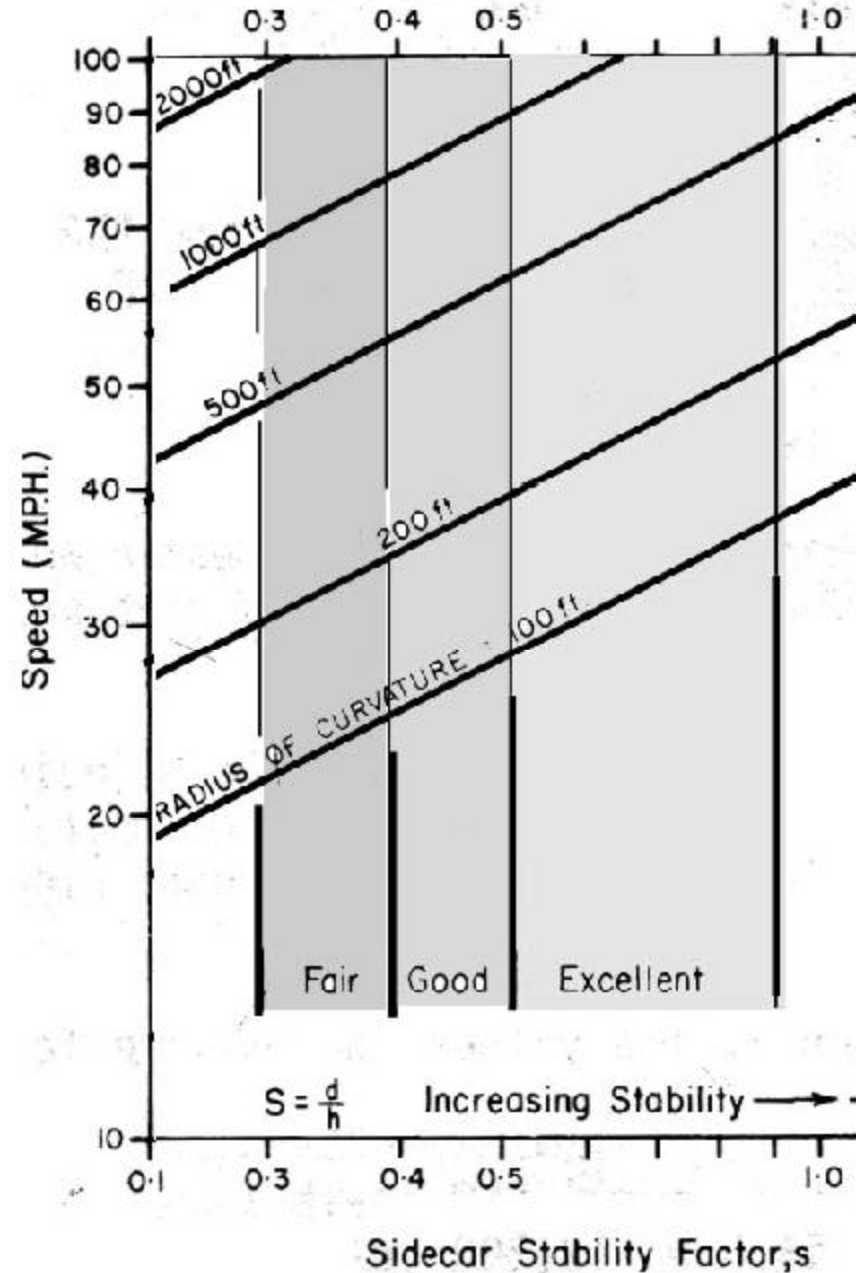

Example 1 is our basic reference bike and sidecar rig.

Example 2 is the same rig except the sidecar is mounted 10 inches further away from the bike.

Example 3. The effect of a sidecar passenger.

Example 4. The effect of adding a 50 pound ballast to the empty sidecar.

**Table 1**

Weights and Moment Arms	<u>Ex. 1</u>	<u>Ex. 2</u>	<u>Ex.3</u>	<u>Ex.4</u>
Bike (lbs)	400	400	400	400
Rider (lbs)-	175	175	175	175
Sidecar (lbs)-	100	100	100	100
Passenger or ballast (lbs) :			150	50
Sidecar and passenger on bike (lbs):	40	40	100	60
Sidecar and passenger on s/c wheel (lbs):	60	60	150	90
Total weight (lbs):	615	615	675	635
C of G of rig above ground (in)-	15	15	20	13
Track width (in)	50	60	50	50

Center of gravity of the outfit by taking weight moments about the bike-wheel-to-ground contact line.

Center of gravity from bike Centerline = (wt\_on\_s/c\_wheel) \* (distance from s/c\_wheel\_to\_m/\_wheels)

(Total wt on bike wheels-- wt on s/c wheel)(7)

Substituting the values from Table 1 into Equation 7, the CoG for our four examples follow-

Center of gravity (1) =  $(60 \times 50) / (615 - 60) = 5.4 \text{ in};$

Center of gravity (2) =  $(60 \times 60) / (615 - 60) = 6.5 \text{ in}$

Center of gravity (3) =  $(150 \times 50) / (675 - 150) = 14.25 \text{ in}$

Center of gravity (4) =  $(90 \times 50) / (635 - 90) = 7.0 \text{ in}$

## SIDECAR OPERATOR MANUAL

Use these values Of C of G, horizontal distances of the C of G, and the height of the C of G above ground, h, gives the following (A/B) ratios and values-

$$\text{Example (1) } A/B = 5.4/15 = 0.360$$

$$\text{Example (2) } A/B = 6.5/15 = 0.433$$

$$\text{Example (3) } A/B = 14.25/20 = .712$$

$$\text{Example (4) } A/B = 7.0/13 = 0.538$$

The (A/B) ratio is found for a particular outfit with a given loading without knowing any weight distribution. With the outfit stationary, and loaded normally, have an assistant lift the sidecar until the outfit is ON POINT OF BALANCE. Use the procedure described earlier.

The (A/B) ratio determined by this method should be the same as the calculation method. It is not difficult to find the horizontal distance the C of G from the motorcycle. The weight on each wheel is found by driving over a weigh-bridge scale. It is difficult to calculate or find the height of the C of G above the ground. If you know the (A/B) ratio from the balance method and have the horizontal distance of the C of G, you can calculate the height of the C of G-

$$B = Ab/a$$

where

B = height of the center of gravity above ground

A = distance of center of gravity from motor-

## 5. SIDECAR DESIGN

cycle wheels

b = horizontal distance determined from balance method

a = vertical distance determined from balance method.

Knowing the (A/B) ratio, you can calculate the critical speed for that outfit for any given radius of turn. Conversely, if the speed is known, you can determine the minimum radius of turn you can safely negotiate. Refer to the chart, p104.

To use the chart, enter at the bottom with the A/B value for the particular bike and sidecar rig. Proceed vertically to the Intersection of the Radius of Turn line, then proceed horizontally to find the velocity. This is the critical velocity for this set of conditions. It is the limiting speed for the sidecar wheel to stay on the road. A slower speed is stable; a faster speed will lift the sidecar.

Rig Number 1 can take a 100 ft radius right-hand turn at 23 mph while Rig Number 2 will lift at 26 mph; Rig Number 3 lifts at 33 mph and Rig Number 4 at 29 mph.

Analyzing the results of the three changes to our basic rig shows all have given increased performance. The 50 pound ballast in Example 4 was more effective than moving the sidecar wheel 10 inches out. Placing a passenger in the sidecar, Example 3, had more effect. The turn was 10 mph faster.

## SIDECAR OPERATOR MANUAL

Looking at a 200 ft radius turn, our speed limitation is increased to 33 mph for Rig Number 1, and to 46 mph for Rig Number 3.

Adding a passenger or ballast improves stability. The 50 pound ballast in Example 4 gave a worthwhile improvement.

The heavier Harley-Davidson and European sidecars weighing 200 pounds or more empty, do not require ballast. Use 50 pounds or so of readily removable ballast for a light-weight sidecar. A novice sidecarist should always use the ballast when the sidecar is empty.

Place the ballast low, close to but behind the sidecar wheel.

A low-slung sidecar is more stable than a high sidecar. It is more pleasing with better lines.

### 5.3.2 Left Hand Turns

The same forces that act on right handers also act on left handers, but in the opposite direction. The overturn pivot line is now from the sidecar wheel to the front wheel. The (A/B) ratio values vary from 2.0 to 4.0, much greater than those calculated for right hand turns. It is very difficult to generate enough centrifugal force to overturn the rig. However, you can flip a rig end-over by taking a left-hand turn too fast or braking hard with the front brake after commencing the turn.

## 5. SIDECAR DESIGN

Because the sidecar acts as a stabilizer during left-hand turns, you take them faster and turn quicker than right-hand turns. The centrifugal force generated is large, the larger the bike, the greater the force. The overturning force transfers to the attaching mounts and struts. It puts the upper attachment members in compression and the bottom ones in tension. You need strong and reliable mounts for large machines of 500 cc displacement and upward.

This example illustrates the amount of force generated in a given turn-

Go to Chart A for a 10 ft radius turn at 20 mph. The (A/B) value is 2.6. This number equals the F/W ratio according to Equation 4. For a large outfit weighing 800 lb with a 175 lb rider aboard -

$$F = 975 \text{ lb} \times 2.6 = 2535 \text{ lb}$$

This centrifugal force is taken by the mounts. A properly designed sidecar and mounting system will handle this force safely. Sidecar mounting struts are loaded more in fast, tight-radius left-hand cornering than in right-hand turning. The loading is proportional to the velocity, turn radius, and total weight of vehicle and occupants.

## 5.4 Turning Model

The following model describes how a motorcycle sidecar outfit behaves while turning. It assumes the driver's input keeps the rig in a curve of a constant radius and maintains the speed constant. The effect of braking any wheel or of acceleration are not included. I welcome input of how acceleration or braking of any wheel may be defined for a later revision.

The base case is a sidecar outfit turning at 100 ft radius, or a curve with a posted speed limit of 20 mph. The driver weighs 185 lbs, the total net weight of the outfit is 950 lbs. The road is flat and without superelevation or camber.

The critical factor in determining the stability of a sidecar outfit is the location of the CoG. The lower the CoG and the further towards the sidecar wheel the more stable the outfit. Pick up the sidecar wheel and note the angle taken to reach the point of balance. If it begins to fall over when you reach an angle of only 10 degrees, it is very unstable. If you reach an angle of 50 degrees, it is very stable. This example assumes a stability angle of 35 degrees.

### 5.4.1 General Stability with Load Placement

We place now place passengers on board, each passenger weighing 200 lbs:

	<b>Driver</b>	<b>P. Pass.</b>	<b>S/C-Pass</b>	<b>Vel (Right)</b>	<b>Vel (Left)</b>
	<b><u>lbs</u></b>	<b><u>lbs</u></b>	<b><u>lbs</u></b>	<b><u>mph</u></b>	<b><u>mph</u></b>
1.	185	-0-	-0-	25.3	55.7
2.	185	200	-0-	21.3	53.8
3.	185	200	200	26.5	52.2
4 .	185	-0-	200	30.7	53 . 2
5.	-0-	-0-	185	36.9	57.2

The worst case is condition, 2, with the passenger on the pillion. If you slowed to the posted speed everything would have been OK. The posted speed was 20 mph.

In our normal driving habits we ignore posted warning signs. We often try to drive through them at double their warning speed. With a sidecar going into a right hander don't do it. You can't. It is not physically possible. Note- this analysis applies to the outfit described. Your outfit may be more stable or less stable.

Note- the passenger SHOULD always be in the sidecar, 4, NOT on the pillion, 2. ALWAYS load the sidecar FIRST. Always put the heavier passenger in the sidecar. If that is not possible add enough ballast until you get the proper balance and SLOW down. Driving with no passengers, 1, is equivalent to driving with a full load, 4. The fifth analysis, 5, shows how a sidecar set up for a paraplegic would handle. It is the MOST stable combination. These rigs have ALL controls needed to operate the motor-cycle set up in the sidecar cockpit. Regardless, one can turn faster to the left than to the right.

These limits are faster than posted speed limits. If a sidecarist bought the farm on a left hander he usually brought it on himself. The speed limit on THIS curve was still only 20 mph.

#### 5.4.2 Critical Speeds versus Stability Angle

Now compare rigs of the same gross weight but having different values of stability angles to reach the balance point-

	<b><u>Stability Angle, degrees</u></b>	<b><u>Vel (Right), mph</u></b>	<b><u>Vel (Left), mph</u></b>
1.	15	17.9	39.4
2.	25	22.1	48.6
3.	35	25.3	55.7
4.	45	28.1	61.7
5.	55	30.6	67.3

As the static stability angle increases so does the critical velocity in both directions. This does NOT mean that a rig with a lower stability angle is unsafe. It means you must recognize the limitations of your rig and operate within those limits.

## 5.4.3 Adding Ballast

Let's add ballast to the rig with a lower stability angle, 2"

	<u>Ballast, lbs</u>	<u>Vel (Right), mph</u>	<u>Vel (Left), mph</u>
1.	-0-	22.1	48.6
2.	50	23.7	48.3
3.	100	25.0	48.0
4.	150	26.2	47.7

The critical velocities improved. If your rig appears light then add some ballast. Ballast is more effective if placed low, close to the sidecar wheel, and behind the sidecar wheel. To some extent, body English is effective. You lean your upper body to the right and you push down on the right handlebar while pushing down on the right footrest. You get some small weight transfer and can take a right hander at a slightly higher speed in more comfort. This effect is small.

Do not expect to take a curve designed for 20 mph at 40 mph no matter how much body English you use. You may increase speed from 20 mph to 25 mph, maybe 28.

## 5.4.4 Effect of Lead

This rig had a sidecar wheel lead of 12 inches and a stability angle of 35 degrees. Let's see the effect of changing the lead, and with no passengers:

	<u>Lead, inches</u>	<u>Vel (Right), mph</u>	<u>Vel (Left) mph</u>
1.	-0-	25.3	50.3
2.	12	25.3	55.7
3.	24	25.3	63.1

Changing lead had NO effect on right handers. That wheel is not in contact with the road surface at the critical speed so its position is not critical. As lead increases so is left hand stability.



Why don't we increase the lead as much as possible? The larger the lead the greater the steering effort required for left handers with greater tire wear. The rigs set up for the handicapped have rapid tire wear with high steering effort.

The other exception is on speedway racing sidecar rigs used in Australia where the lead is between 18 and 24 inches. These rigs turn ONLY away from the sidecar and always on a gravel/clay surface. Their trail is between 1/2 and 1 inch to reduce steering effort.

#### 5.4.5 Increase in Track Width

Other factors the same, let's increase track width-

	<b><u>Track Width, inches</u></b>	<b><u>Vel (Right), mph</u></b>	<b><u>Vel (Left), mph</u></b>
1.	36	23.9	52.4
2.	48	25.3	55.7
3.	60	26.4	57.9

A wider track makes a more stable outfit but it increases pendulum forces when accelerating or braking. It also increases wind drag and mechanical drag forces.

The high speed European rig set up for Autobahn use has a track width of 43 inches. The typical US outfit uses a track of 48 inches. A double width unit has a track width of 60 inches.

5.4.6 Changes in Road Crown

So far we considered factors over which we have some control. Now consider road crown which is from minus 10 degrees up to plus 15 degrees. The degrees of banking on a fast track is greater.

Effect of super elevation or road camber-

	<u>Road Elev. deg</u>	<u>Vel (Right), mph</u>
1.	-24	UNSTABLE
2.	-20	9.5
3.	-i0	18.8
4.	-0-	25.3
5.	+i0	31.3
6.	+20	37.4
7.	+40	54.5
8.	+60	113.7

Be very careful on right handers with a reverse camber. SLOW down.

Note- you can make FAST right handers IF you on a banked test track AND going in the proper way.

5.4.7 Turning Radius

Most roads have an elevation of 5 to 16 degrees. We leave the elevation at 10 degrees and see the critical velocities for different turning radii. We also compare these to posted speed limits for those curves:

5. SIDECAR DESIGN

	<u>Rad, ft</u>	<u>Turn Vel (Rt) mph</u>	<u>Post mph</u>
1.	25	16.1	10
2.	50	22.8	15
3.	100	32.3	20
4.	250	51.0	30
5.	500	72.1	40
6.	1000	102.0	60

If you never exceed the posted speeds you should never have a problem with a right hander. You come to grief only when you exceed the limitations of the rig or the road design.

WARNING- The above presupposes that the road surface is dry and of bitumen or concrete with no loose sand or other debris. Slow down for ANY adverse road or weather situation.

5.4.8 Summary

In summary,

(1) Right-hand turning is a matter of rider knowledge of the forces and moments acting. He must respect these factors.

He must develop his skill and experience to deal with them to handle his sidecar rig safely. Body English will help.

(2) Left-hand turning, even relatively hard left-hand turning, is less a problem. It is done with less fear and safer.

## 5.5 Gearing

Optimal performance with a sidecar outfit is obtained when the machine is set up with the correct sidecar gearing. Engine size is a minor consideration. You created a very different machine from the way it came from the factory.

The manufacturer correctly set your machine so it pulls at red line rpm at maximum speed. This is where the effective horsepower developed at the rear wheel equals to the horsepower to overcome wind resistance and mechanical drag. High gear is assumed. If the high gear is an overdrive, then the maximum speed is obtained in the next lower gear.

Mechanical drag is normally directly proportional to load. The load pulled is increased by the weight of the sidecar and any passengers. However this does not include the drag created by the toe-in of the sidecar wheel.

Tests performed in Germany show that toe-in increases mechanical drag by up to 50 percent or more. The weight addition was just 20 or 25 percent. Mechanical drag, from any source, must be overcome by engine horsepower. If the speed is doubled you must also double the horsepower to overcome mechanical drag.

Air resistance must also be overcome. Unlike mechanical drag the air flows over the sidecar outfit in turbulence. The force required to overcome turbulence increase with the square of the velocity. This

## 5. SIDECAR DESIGN

means the power required increases with the cube of the velocity. If it takes 10 hp to overcome air drag of a particular vehicle at 40 mph, it needs 80 hp to overcome air drag at 80 mph.

The basic drag equation includes a shape or streamline factor, and the cross-sectional area of the body. A motorcycle is shaped like a block as far as streamlining is concerned. It has a drag coefficient of 0.7, the same as a city bus. A basic sidecar is not much better shaped than the motorcycle.

By comparison, a streamlined car has a drag coefficient of 0.35. A streamlined sports car gets the drag down to 0.2 or less.

A motorcycle displaces about 6 or 7 square feet of frontal area. Add a sidecar and the frontal area doubles. At speeds up to about 50 mph, air drag is not too bad. Power consumed to keep a vehicle in motion mainly overcome mechanical drag. At higher speeds it is air drag that predominates.

A general equation for horsepower required for a sidecar outfit is:

$$\text{hp} = 0.07 * V + 0.00005 * V^3$$

From this equation the following table is derived-

## SIDECAR OPERATOR MANUAL

<b><u>mph</u></b>	<b><u>solo hp</u></b>	<b><u>SC outfit hp</u></b>	<b><u>engine hp</u></b>
10	0.4	0.8	1.1
20	0.9	1.8	2.5
30	1.8	3.5	4.8
40	3.1	6.0	8.4
50	5.0	9.8	13.6
60	7.7	15.0	21.0
70	11.4	22.1	30.9
80	16.1	31.2	43.7
90	22.1	42.8	59.8
100	29.4	57.0	79.8
110	38.4	74.3	103.9

The first column shows the approximate horsepower necessary to propel a two wheel cycle at the speed indicated. It is not engine horsepower which will be higher because of transmission and tire losses. The second column is that required for a typical sidecar outfit.

The last column takes transmission losses into account for the sidecar rig only. Note that horsepower requirements increase drastically at higher speeds. If you ain't got it you can't get there.

In this example, if your bike can do 110 mph in solo trim you might be able to do 85 mph with a sidecar. That is, if you can pull at near the red line by increasing your gearing by 29 percent.

## 5. SIDECAR DESIGN

We don't normally drive at the red line if we respect the engine. We settle for a modest increase in gearing of 10 to 15 percent, a good compromise for larger displacement engines.

An increase of 20 to 25 percent is better for smaller machines. This gives similar acceleration with the sidecar outfit as you had with the machine in solo trim in your normal cruising range. You find you get off the mark much easier with minimum clutch slip. Starts up a hill are easier, you can get out of lower gears faster, and do not spend your time changing gears. With the engine operating higher in the power band there is little chance of lugging the engine.

Now you appreciate how important it is to change gearing, how can you do this? With a rear chain drive there is no problem. You increase the number of teeth on the rear sprocket by 4 or go up two teeth on the rear and down one tooth on the rear gearbox sprocket.

How can you handle a shaft drive? You could fit a sidecar gear set for the older BMWs. Special gear sets were available for the Gold Wing. It may be difficult but there is another way.

The Europeans showed us when they fitted slim radial auto tires on special rims. In addition to providing a near optimum gearing increase of about 12 percent they also lowered the C of G an inch or so. This improved overall performance and handling. The tires were nearly indestructible.

## SIDECAR OPERATOR MANUAL

When they also fitted the front end with leading link forks and the 15 inch slim auto tire the combination was unbeatable.

The auto tires are NOT the tires you can get at a service station but special tires used for the front end of drag racers, for off-road vehicles, and the Citron 2CV. The slim tire is a 125 SR 15 or the larger 135 SR 15.

Some have fitted larger and fatter 15 inch tires to sidecar outfits but that is not recommended. Auto tires should only be fitted to auto rims because of critical dimensional differences.

### 5.6 Brakes

Never compromise the braking system on a sidecar outfit. Federal law requires two separate systems on a motorcycle. If a single system is used it must be split hydraulically so if one system fails there is a backup system.

I use a dual disc system up front, and a twin leading shoe at the rear. A separate pedal controls the sidecar brake which is a single leading shoe system.

An optimum system may have twin hydraulic discs up front, a single rear hydraulic disc at the rear, and a single hydraulic disc on the sidecar wheel. It may be possible to hook the rear brake to one of the front discs and to control this with the foot control.

## 5. SIDECAR DESIGN

The hand control could operate the other front disc and the sidecar wheel brake. This sounds perfect. I have not attempted can give no recommendation. If someone has first hand experience with this system perhaps they will share with us.

A sidecar brake, if hooked to the front brake system, could be a plus if one wished to do aggressive right handers.

Your machine must stop, even when loaded in the following distances.

<b><u>Speed, mph</u></b>	<b><u>Distance, ft</u></b>
20	19
30	43
40	75
50	128
60	185
70	264
80	345
90	484
100	598
110	723

The above table is from FMVSS No. 122.

Brake testing is done professional brake testers.

The table on the previous page is for good braking, not superior braking. The Ninja can stop much quicker. The table does not appear to be too bad as a reference.

Forget the States requirements unless they have tighter specifications. Texas law requires that you must slow down from 20 mph to zero in 50 ft. You could do that with just the sidecar brake, or by putting your foot on the ground!

If you have a mechanical brake for the sidecar you may need some imagination to make it usable. I hooked up such a system to a separate foot control, and on another rig to a separate hand control. I have also tied it to the rear brake system, mechanically. With patience these systems can work fairly well but are nowhere near as good as a full hydraulic system with a splitter.

## 6. THE WORLD OF SIDECARING

Sidecarists are brothers throughout the world. We take care of our own and of any who share an interest in our unusual vehicle.

Several major sidecar clubs exist, with many more smaller clubs scattered throughout the world. A brief history of some of these clubs will enable you to choose which is right for you. We will add your club to this directory in future editions. Any member of any club should ask his Secretary to prepare a brief history and send to the Secretary of the United Sidecar Association, Inc.

### 6.1 Clubs and Associations

The following list is updated as information becomes available.

#### 6.1.1 The United Sidecar Association, Inc.

The concept of the United Sidecar Association began in mid 1976 when Hal Kendall asked Ed Johnson about motorcycle insurance. Although Ed did not sell Hal any insurance, the United Sidecar Association, Inc. was born. Terry Strasenberg completed the list of Founding Fathers as Treasurer. Ed was an executive officer of the Pullman Hackers, a local Chicago motorcycle club. Hal had pulled together the International Laverda Owners Club and the Association of Jensen Owners. Executive and organizational talent was at hand. Ed wanted a national club. His dreams were soon realized.

## 6. WORLD OF SIDECARS

Membership grew to around 25 by late 1977. In early 1978, Bill Espe, Co-Founder of the 3rd Wheel, Inc. joined the USCA, Inc. as Editor and National Coordinator. The Newsletter took on a more professional appearance.

Sidecarists saw Bill at many rallies nationwide, while Hal had several articles published in many motorcycle publications. He also presented papers on safety and lighting to the Motorcycle Doctors Association. He led a successful charge against excessive tolls for sidecars by the Tollways.

Connie Brown joined the executive committee by year's end. As a result of the dedication of many members, membership grew over 1000 percent during 1978. Members joined from every State and some came from overseas.

In mid 1979, Doug Bingham became the first President of the USCA, Inc. Under Doug's astute direction, the USCA, Inc. was soon the largest sidecar association in the America. It functions in a fashion similar to the Federation of Sidecar Clubs in England. It serves the sidecarist as the American Motorcyclist Association, the Motorcycle Safety Foundation, and the Motorcycle Industry Council serve the solo motorcycle rider. The USCA, Inc. actively supports positive legislation and bikers' rights. It opposes restrictive legislation. A membership emergency contact scheme assists stranded members along the highways and byways.

## SIDECAR OPERATOR MANUAL

Doug became a Director in Watsonion Sidecars and resigned as President of the USCA, Inc. Hal Kendall became President in 1987 and chose a new board of officers. This heralded in a new era where all officers were elected.

More recently, they have gone to electronic publishing and have a very active website at [www.sidecar.com](http://www.sidecar.com).

The Sidecarist, the official regular news journal of the USCA, Inc., is the most technical and informative journal on and about sidecars and sidecaring in America.

Contact: The Editor/Membership Contact/Bookshop, USCA, Inc. c/o Al Roach, 130 South Michigan, Villa Park, IL. 60181-2526.

<http://www.sidecar.com/>

The wide geographical distribution of the committee enables it to observe the needs of members everywhere. In addition to promoting sidecar riding skill seminars, the USCA, Inc., is active in promoting local chapter rallies and events. The National Rally is the BIG EVENT. Other sidecar clubs can affiliate with the USCA.

### 6.1.2 The Third Wheel, Inc.

Co-founded February 5, 1971, by Bill Espe and John Hughes. Don and Virginia McGillivray hosted the first club in October, 1971 with six sidecars attending. Total membership for 1971 seven.

## 6. WORLD OF SIDECARS

The first national sidecar rally was at Menomonie, Wisconsin in July, 1975. By the year's end the club had grown to 123 members. Over the next three years the membership grew to three hundred. The Third Wheel is a family-oriented sidecar club with monthly meetings and many outings during the riding season. The highlight of the riding schedule is the Mid-America Sidecar Rally each year. The Third Wheel faded away.

### 6.1.3 The Northwest Sidecar Pilots

The Northwest Sidecar Pilots started with three principals - Bob Bolton, Bruce Bolton and Bill Powell. They felt other people in the Northwest had a similar interest. The club's growth has been quite erratic since their beginning in 1976. There have been as many as fifteen members and down to the current hard core group of six member families. Some people get into sidecaring only to find that they do not enjoy it as much as solo touring.

The Club is an Un-Club. They have no organization nor elected officials. Their interests are in riding. Bill Powell has been Acting President the last several years. Jobs are spread among members according to his or her specialty.

Bruce Bolton is an excellent mechanic. Dave Rigby is a Machinist and installer. Bill Powell is Jack-of-all-Trades as are the rest of the core members. Al Benoliel is Club Contact person - he has the connections for getting something done.



## SIDECAR OPERATOR MANUAL

Club patches are available and worn on blue windbreakers. Principal activities include touring and camping in the Northwest. This area is a beautiful spot for these activities. Their scheduled campouts attract sidecar riders from other parts of the Northwest. There are also many unscheduled day rides.

Contact- W. (Bill) H. Powell, Northwest Sidecar Pilots, 7290 E. Harrison, Port Orchard, Washington, 98366.

### 6.1.4 The American Sidecar Association

The American Sidecar Association began in 1970 under the watchful eye of Doug Bingham, owner of Side Strider, Inc. The first Griffith Park Sidecar Rally, in 1972 was a success. Each year it grows better. In addition, the A.S.A. had participated in various motorcycle shows throughout the years in different places and in parades. The A.S.A. became part of the USCA in 1981.

### 6.1.5 Northern Illinois Sidecarists

The Northern Illinois Sidecarists is the birthchild of Ed Johnson to provide an outlet for sidecarists in the Mid-Continent states, and especially the annual Polar Bear Run which predates the USCA. For information, contact 24712 Cottage Road, Wilmington, IL, 60481

## 6. WORLD OF SIDECARS

### 6.1.6 The Federation of Sidecar Clubs (UK)

The Federation is a "mother club" which coordinates the activities of forty sidecar clubs in the United Kingdom. In addition, it maintains close active links with many sidecar organisations or associations around the world.

Through the Associate Section they offer individual memberships to any sidecar owner anywhere in the world. Individuals who do not want to join a club are welcome in the Associate Section.

The Federation, founded in 1958, celebrated its 45th anniversary in 2003. As a social club for sidecarists it encourages runs, rallies, camping weekends, socials, dances, and other events. They are an active voice in road safety and legislation. They serve as the official spokes-group in matters relating to sidecaring in England. They operate an emergency contact scheme which assists members in need. emergencies include mechanical trouble, or requiring overnight accommodation.

The Federation Technical Advisor provides advice to members inquiries on sidecaring matters while their Legal Advisor monitors potential legislation. The Legal Advisor also liaises with other motorcycle organisations and the Department of Transportation.

Contact addresses listed at the end of this section.

## SIDECAR OPERATOR MANUAL

### 6.1.7 The Swedish Sidecar Club

The Svenska Sidvagnsklubben (SSK) produces a very excellent News Journal in Swedish. It is very well illustrated and full of technical information. They began in 1968, with 8 members. Their membership now stands at 120. No recent word.

### 6.1.8 The Finnish Sidecar Association

The Finnish Sidecar Association began in 1985. Their club news letter comes out every four months to serve their 140 members.

The Jumbo run is in May. The last Run brought 42 sidecar outfits. Another meet is at the end of summer. For details contact Heikki Arvelin at 17120 Paimela, Finland. No recent word.

### 6.1.9 The Norwegian Sidecar Club

The Nordic Sidecar Club began in 1974 and now has 120 members. Their main Jumbo run is in May with other meets in summer and in autumn. Twelve Jumbo runs were held at a location just north-east of Trondheim.

For details contact S.Borgersen, Hoyasveien28, N-3700 Skein. No recent word.

### 6.1.10 Sidecar Owners Club of Sydney

John McCormack, John Bennett, and John and Peter Michalk organized the SOCS in 1984 to

## 6. WORLD OF SIDECARS

promote sidecars and sidecaring. Membership had increased to 65 adults and fifty children by 1988.

Growth has been rapid the past few years due to the efforts of one member, Ron Hurdis. Ron manufactures HRD sidecars and offers instruction in sidecaring techniques. Potential sidecarists come to the club seeking technical advice, then become long time club enthusiasts.

Contact Susan White, President for details

6 Gum St., Greystanes, NSW 2145

No recent word.

### 6.1.11 Amicle Sidecariste de France

The ASF began in 1986 and have 550 members in their 1988 roster. Their magazine, the Sidkar, is very well informed. Their rallies are international with their first held in St. Lo in Normandy in 1986, and the next in the Alps at St. Nizior du Moucherotte.

The ASF held a booth at the Race 29th du Mans with a Yamaha 900XJ attached to a Hechard sidecar. Their latest ASF rally was in La Rochelle in Charentes Mountains.

## SIDECAR OPERATOR MANUAL

### 6.1.12 JSC Japanese Sidecar Community

The Japanese Sidecar Community has been around since the 1970s.

Hajime Karasawa, 983 Saiwaicho 2-5-11

Sendai, Miyagi, JAPAN

<http://www.jsc.org/>



=====  
<http://www.motorrad-gespanne.de/links.htm>

Martin Franitza, Brunnssteinstrasse 3

8058 Erding, FEDERAL REPUBLIC OF GERMANY



## 6. WORLD OF SIDECARS

### 6.2 Sidecar Clubs, Associations, and Contacts Around the World

#### All Ohio Sidecar Club

Lincoln and Betty Baird

4638 Winchester Pike, Columbus, OH 43232

#### Amicale Sidecariste de France

Marc Thouret, Residence les Vikings

Batiment Danemark App 21, 50 i00 Cherbourg

#### Bigfoot Sidecar Club

Ben Nukoop, 34221 Hartmen Ave., RR 6, Mission, BC, CANADA V2V 6V2

#### Canadian Sidecar Owners Club

Vi and Osie Shanks, RR #1, Williamsford

Ontario, CANADA NOH 2VO

<http://www.sidecar.com/csoc/>

#### Cascade Sidecarists

Mike Phillips Phone - (503)288-3351

3838 N. Massachusetts, Portland, OR 97227

#### Central Indiana Sidecar Association

Rob Valdez, Chapter Director Phone (317)545-128342

## SIDECAR OPERATOR MANUAL

Danish Sidecar Club - Dansk Sidevogns Klub  
Poul Christenson, Panbovej 4, Kirke Horup  
6400 Sonderborg, DENMARK

### Federation of Sidecar Clubs - United Kingdom

#### Affiliated Club Listing-

Ray Albans, 22 London Rd., Newport, Pagnell,  
Bucks. Phone - (0908) 610725

#### Individual Memberships-

Cliff Day, 28 Meadway, Warlingham, Surrey CRW  
9RW Phone - (08832) 6679

#### Technical Information-

Doug Feveyear, 21 Taylor Rd., Hadleigh, Ipswich,  
Suffolk Phone- (0473) 827680

### Finnish Sidecar Association - Suomen S ivuvaunuyhdistys

Heiki Arvelin, 17120 Paimela

FINLAND

### France

Patrick Forest, 6 Place de la Republique

78530 Buc Village, FRANCE

## 6. WORLD OF SIDECARS

### Great Lakes Sidecarists

Barry Alexander

P. O. Box 300, Lakeland, Michigan 48143

### Northwest Sidecar Pilots

Bill Powell, 7290 E. Harrison

Port Orchard, WA 98366, USA

### Norwegian Sidecar Club - Norsk Sidevogn Klubb

Svein Borgersen, Hoyasveien 28

N 3700 Skien, NORWAY

### Queensland Sidecar Club - Australia

Julie Sweeney

4 Wallace St, Toowoomba, QLD 4350

### Sidecar Owners Club of Sydney - Australia

Susan White, 6 Gum Street

Greystares, New South Wales, 2145

### Sidecar Racers Association

Mike Orchard

1315 Fundy Court, Oshawa, L1J 3N5 , Ontario,  
Canada

## SIDECAR OPERATOR MANUAL

Swedish Sidecar Club - Svenska S idvagnsklubben  
Totte Dahlberg, Svartbrodragat 4  
26400 Klippen, SWEDEN

the Third Wheel, Inc.

Estelle Hasert

4109 Boardman St., Minneapolis, MN 55417

United Sidecar Association, Inc.

Membership Contact-

Al Roach, 130 So. Michigan St.

Villa Park, IL 60181

## 6. WORLD OF SIDECARS

## APPENDIX - - Sidecar List

(P)- In current production

### UNITED STATES

American Easy Rider

Automarket - "Kenna" (see Canada)

Bustec

California Sidecar - "Spirit of America"

(P) California Sidecar, Inc - "Side Kick" "Commuter" • "Companion", " Friendship I", "Friendship II"

Centaur

Cosmopolitan- "Mini-Sidecar"

Cushman - For scooters

Cycle Camper

Cycle Mate

Cyclemotive- "Sport"

Dryer

Essix

Equalean

Flxible- Single Seater, Twin Seater, Racing, Rigid

Freedom Sidecar - "Freedom"

Gemini

(P) Good One

Goulding

(P) Harley-Davidson

(P) H - D Replica

## 7. SIDECARS PAST & PRESENT

Heath Tool - "Sidekick"

(P) HitchHiker

Indian- SC20 Chassis "45" and "74", VBIOI - closed panel, SC21 Chassis for Indian "4", VBIO2 -Open express, VBIO3 (closed box), VBIO5 (open box), VCI5 Commercial Van Chassis for "45" or "74."

International

Millray "Coupe Royal"

(P) Motorvation - "Spyder T-I", "Coupe Royale", "Formula II", "Roadster Royale"

Morrow- "Style i", "Style 2"

(P) Pearson

Rambler

Ride-by-Side

(P) Seth Thomas

" "RS"

" "Mk II,

Sidestrider - "Bingham Mkl,

Simon

Spirit - "Spirit Eagle," "American Spirit"

Vetter -"Terraplane"

Thompson- "Cyclecar"

Thor

Universal

Yale

Zephyr

## SIDECAR OPERATOR MANUAL

### UNITED KINGDOM

A J S

Ariel (Components/Liberty - Montgomery)

Austel

Baxter B-K-W

Blackness - "Derby," "Carrington," "Bullet," "San Remo" Boret, (Custom Racer)

Bowser Bramble

B.S.A. - "20," Taxi, 23/51 d-a, 22/47 Deluxe Tourer, 22/51 Saloon, 22/48 Box, "Australite"

Briggs - "Lightweight Sports MK1, MK2," (Lightweight, Child/Adult)

Busmar - "York" d/a, Lancastria, Austral" d/a "Astralelle"

s/s, "Lincoln" s/s Saloon, "Devon" Family Saloon.

Butler

Cedos

Collapsible (Forerunner to Watsonian)

Canterbury - "Belle," "Busmobile," "Ca obile," "Viking," "Invader," "Conqueror," all /a; "Saxon," "Gladiator," "Victa," all c/a; "Crusader," "Warrior," "Challenger," all s/s; "GMC 7T Competition," "Devon" s/s Lightweight, and a Heavy and a Medium Box.

Castle - "Countess," "Diplomat," "Courier" "Princess"

Charter-Lea

## 7. SIDECARS PAST & PRESENT

Cooper

Cibe Crown - "Lance" c/a

Garrard - "S-90 " "Silchester " "Gazelle," "Pixie." "Sildester," "Regent," "Royalist"

Gemini - Child/Adult, Double Adult, Three/Four Seater, Three/Four Seater Lo-Line

Gobank - s/s, c/a, Lightweights

Gloria - Model B

Graham Bros Graislely

Hagon - Grass Track Specials

(P) Hedingham

Hughes Kerswell Liberty Matchless M-G-F

Milford - (Mills and Fullford)

Montgomery

Norton - Models "G," "H," "J", "M"

Noxal - "Airflow," "Paramont"

O.E.C.

Professional

Puma - Competition Only

P M B - (Plastic Motor Bodies)

Rankin - "Stafford," "Bieford," "Watford," all d/a; "Lifford," s/s

Raven

Regent (Includes Vauxhall engine)

R G M Budge Rumble Scott

(P) Sidewinder

## SIDECAR OPERATOR MANUAL

### UNITED KINGDOM (Continued)

(P) Squire - "ST1," "ST2," "RSL," "PVL," "CV1"

Sunbeam - "S22/30," "SS Tourer," "S23/52 Family"

Surrey - "Coulsdon" c/a, "Rambler" s/s, "Gossamer" s/s, Box

Swallow - "Jet 80," "Commando," "Comet," "Super Sports," "Commodore," "Vulean," "Viscount," "Tudor"

Touchstone Productions "Saluki," "Terrier"

Trafalger Trinder Trinity

(P) Wasp - "Mk 1," "Mk II," "Mk III" (Grass Track)

Watsonian - "Monarch," "Colonial Cabriolet," "Kwickfit," "Kenilworth," "Maxtroke Saloon," "Bambini" - for scooters, "Avon," "Albion Coupe," "Flight," "Ascot," (P) "Grand Prix," "Palma," "Monza," "Monaco," "Cotswold" "Oxford", "Cambridge"

Wessix

Windle - (Racing) Wing - Kit

### OTHER COUNTRIES

#### Austria

Felber

## 7. SIDECARS PAST & PRESENT

### Australia

Bolt-on

Dusting

DJP

Goulding

(P ?) HRD Murphy

(P) Premier

QSB

Sidecar Engineering

Southern Cross

Suncoast Tilbrook

West Coast

Yates

### Belgium

(P) EZS

F - N

### Brazil

(P) Amazonas

### Canada

G.E.P. Sidecars

(P) Gazelle

(P) Hannigan - "Astro" "Classic"

(P) Kenna



## SIDECAR OPERATOR MANUAL

### China

(P) Chan-jian

(P) Don-hai

### Czechoslovakia

(P) Motokov - "Velorex"

### Country Unknown

J.G.M.

### Denmark

A. C. A. P.

Bender - "LV," "JM" Nimbus

Star

### Finland

(P) Finntour France

(P) Choda

(P) Comete

(P) Hechard

(P) Jeaniel

(P) Jewell

Luxus

(P) Motoside Robache, rte.

(P) Panda Precision

## 7. SIDECARS PAST & PRESENT

### Germany - East

(P) MZ

### Germany - West

Ardie-Werke

(P) Bauhs & Piekert (helper frames, mounts)

BMW - "284 (for R25), 278 (for R67), R12 (Military), R75 (Military)"

Binder

(P) Busch

(P) Carell

(P) Delphin

D-Rad Deutsch Ind-Werke - "Touren Modell"

Goldstein

(P) Hartmann

(P) Heos

Kali - "K103, KL, 103, K104, K107, K110, Kill, KL111, KS154"

(P) Koch

(P) LCR

(P) Lefevre

(P) Mailhammer

Muller - "Clipper R 3"

NSU - "Touren Modell"

Royal - "RS, RSA, RSG, RT"

P) Sauer

## SIDECAR OPERATOR MANUAL

### Germany - West Continued

Steib - "LS200, LT200, S250, S350, S501, TR 500, Roller 1"

Stolzenberg

Stoye

(P) Troika

(P) Walcher

(P) Walter

Wilmsen - "Bantam, SM350, SM500, P "

### Hungry

Duna

### India

(P) Globe - "GS-200" , "GS-350" , "TR-500"

### Italy

(P) Longhi

### Japan

Sanshin (Boat)

Rikuo (W.W.2, Military)

Tairiku - Standard, Deluxe, GT I Beiwagon

Matsushita - Standard, Sports Norimonoyals

Kamdgaya

## 7. SIDECARS PAST & PRESENT

### Japan Continued

Rabbit Scooter w/DSI Sidecar Silver Pigeon w/  
Sidecar Meguro Z w/Sidecar Rikuo VFD w/LTS  
Sidecar Cabton RTF w/CS Sidecar Fuji-Kogyo -  
"Minato" Yasui-Kogyo - "Yasui" Izumi-Kogyo

### Netherlands

(P) E. M. L.

J.A. Bon - "Hollandia"

(P) Moturist

(P) VMC

### Russia

(P) Cossack

(P) Dniepr

(P) Jupiter

(P) Neval

(P) Ural

### Sweden

(P) Corda

### Switzerland

Condor

Haller

(P) Hegi Motors (P) HMO

(P) LCR (Racing)